

# IOM

INSTALLATION OPERATION  
& MAINTENANCE

# A075

METAL 3/4 INCH

AIR-OPERATED DOUBLE-DIAPHRAGM PUMP



# TABLE OF CONTENTS

SECTION 1	WARNINGS, DANGERS AND CAUTIONS	3
SECTION 2	MODEL DESIGNATION MATRIX & REPAIR KITS	4-5
SECTION 3	PRINCIPLES OF OPERATION	6
SECTION 4	DIMENSIONAL DRAWINGS	7-8
SECTION 5	PERFORMANCE CURVES	
	RUBBER DIAPHRAGMS .....	9
	TPE DIAPHRAGMS .....	9
	PTFE DIAPHRAGMS .....	9
SECTION 6	INSTALLATION	
	INSTALLATION .....	10-11
	TROUBLESHOOTING .....	12
	OPERATION .....	13
	MAINTENANCE .....	13
SECTION 7	REPAIR AND ASSEMBLY	
	PUMP WET END REMOVAL .....	14-15
	AIR VALVE REMOVAL .....	16-17
	PILOT VALVE REMOVAL .....	18-19
	TORQUE SPECIFICATIONS .....	19
SECTION 8	EXPLODED VIEWS AND PARTS LISTS	20-25
SECTION 9	ELASTOMERS	26
SECTION 10	WARRANTY AND REGISTRATION	27

# CAUTIONS — READ FIRST!

READ THESE WARNINGS AND SAFETY PRECAUTIONS PRIOR TO INSTALLATION OR OPERATION. FAILURE TO COMPLY WITH THESE INSTRUCTIONS COULD RESULT IN PERSONAL INJURY AND OR PROPERTY DAMAGE. RETAIN THESE INSTRUCTIONS FOR FUTURE REFERENCE.

**WARNING** Pump, valves and all containers must be properly grounded prior to handling flammable fluids and/or whenever static electricity is a hazard.

**WARNING** Prior to servicing the pump, ensure that the air and fluid lines are closed and disconnected. While wearing personal protective equipment, flush, drain and process liquid from the pump in a safe manner.

**WARNING** The TX marking refers to the maximum surface temperature depending not on the equipment itself, but mainly on operating conditions. In this case, the maximum surface temperature depends upon the temperature of the process fluids.

**WARNING** For pump models with non-metallic manifolds, air valves, or chambers: When the relative humidity in the surrounding atmosphere is above 30%, the equipment must not be touched by personnel unless first wiped down with a damp cloth.

**WARNING** Maintenance must not be performed when a hazardous atmosphere is present.

**WARNING** Use only with liquid process fluid.

**WARNING** This equipment's ambient temperature range is 32°F (0°C) to 104°F (40°C)

**WARNING** Do not operate the pump with fluids or in temperatures which are less than 32°F (0°C)

**CAUTION** The temperature of the process fluid and air input must be no more than 36°F (20°C) less of the maximum temperature allowed for the appropriate non-metallic material. See the list of temperatures below for each material's maximum recommended temperature:

Buna-N (Nitrile):	10°F to 180°F (-12°C to 82°C)
Geolast®:	10°F to 180°F (-12°C to 82°C)
EPDM:	-40°F to 280°F (-40°C to 138°C)
Santoprene®:	-40°F to 225°F (-40°C to 107°C)
FKM:	-40°F to 350°F (-40°C to 177°C)
PTFE:	40°F to 220°F (4°C to 104°C)
Polyethylene:	32°F to 158°F (0°C to 70°C)
Polypropylene:	32°F to 180°F (0°C to 82°C)
PVDF:	0°F to 250°F (-18°C to 121°C)
Nylon:	0°F to 200°F (-18°C to 93°C)

Temperature limits are solely based upon mechanical stress and certain chemicals will reduce the maximum operating temperature. The allowable temperature range for the process fluid is determined by the materials in contact with the fluid being pumped. Consult a chemical resistance guide for chemical compatibility and a more precise safe temperature limit. Always use minimum air pressure when pumping at elevated temperatures.

**WARNING** = Hazards or unsafe practices which could result in severe personal injury, death or substantial property damage

**CAUTION** = Hazards or unsafe practices which could result in minor personal injury, product or property damage.

**CAUTION** It is the end user's responsibility to maintain the process fluid's temperature during use.

**CAUTION** Do not connect a compressed air source to the exhaust port of the pump.

**CAUTION** Do not lubricate air supply.

**CAUTION** Do not exceed 120 psig (8.3 bar) air-inlet pressure.

**CAUTION** Do not exceed 10 psig (0.7 bar) or 23 ft-H<sub>2</sub>O suction pressure.

**CAUTION** Ensure all wetted components are chemically compatible with the process fluid and the cleaning fluid.

**CAUTION** Ensure pump is thoroughly cleaned and flushed prior to installation into a process line.

**CAUTION** Always wear Personal Protective Equipment (PPE) when operating pump.

**CAUTION** Close and disconnect all compressed air and bleed all air from the pump prior to service. Remove all process fluid in a safe manner prior to service.

**CAUTION** Blow out all compressed air lines in order to remove any debris, prior to pump installation. Ensure that the muffler is properly installed prior to pump operation.

**CAUTION** Ensure air exhaust is piped to atmosphere prior to a submerged installation.

**CAUTION** Ensure all hardware is set to correct torque values prior to operation.

**CAUTION** The equipment must be inspected for visible damage prior to use.

**WARNING** This product can expose you to chemicals including Nickel, Chromium, Cadmium, or Cobalt, which are known to the State of California to cause cancer and/or birth defects or other reproductive harm. For more information, go to [www.P65Warnings.ca.gov](http://www.P65Warnings.ca.gov).

# MODEL DESIGNATION MATRIX & REPAIR KITS- ALUMINUM

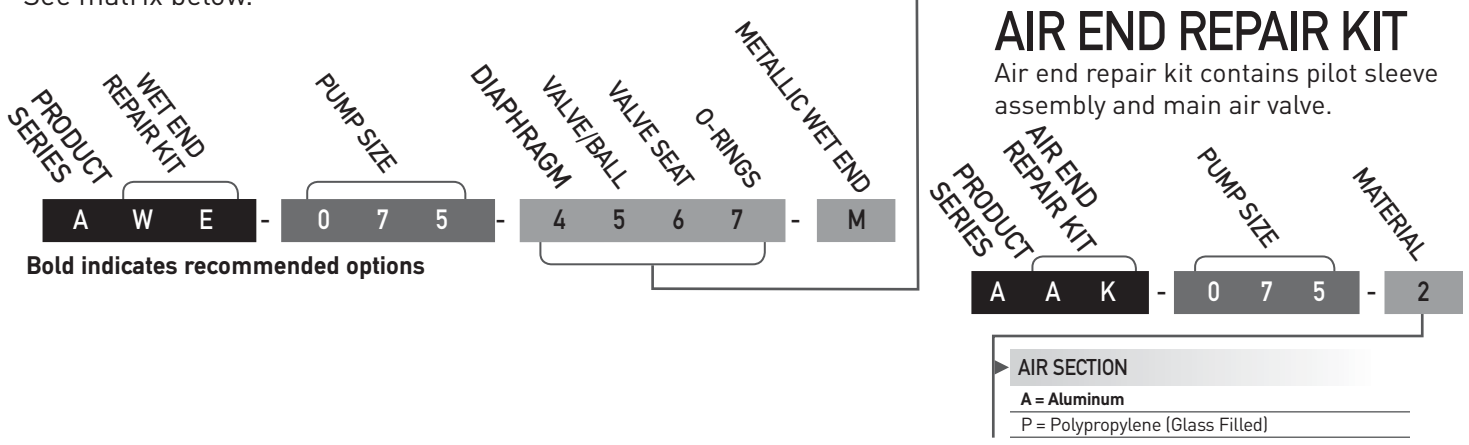
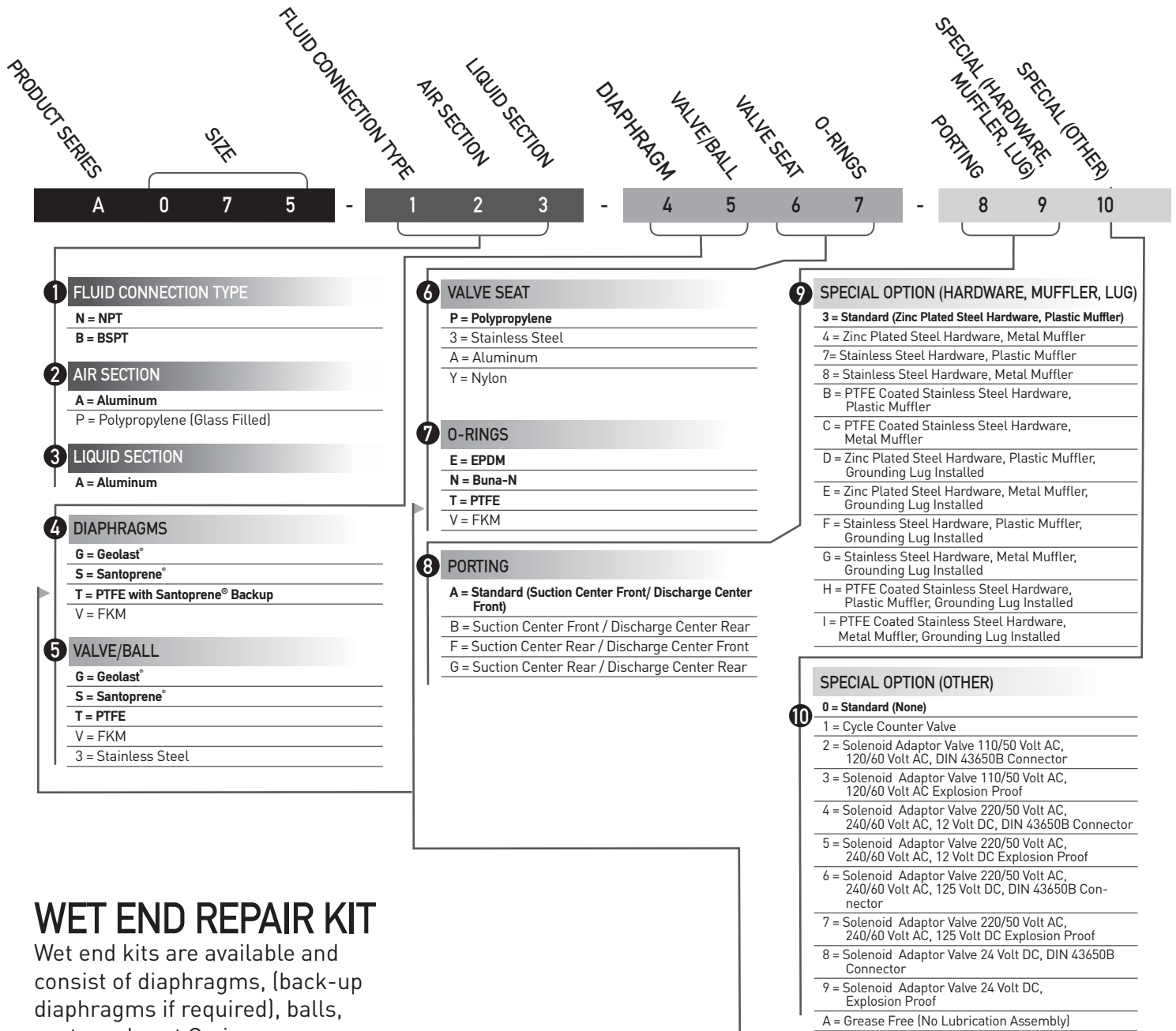

\* Solenoid Adaptor Valves only available on select pump models with polypropylene intermediate

# MODEL DESIGNATION MATRIX & REPAIR KITS - STAINLESS STEEL

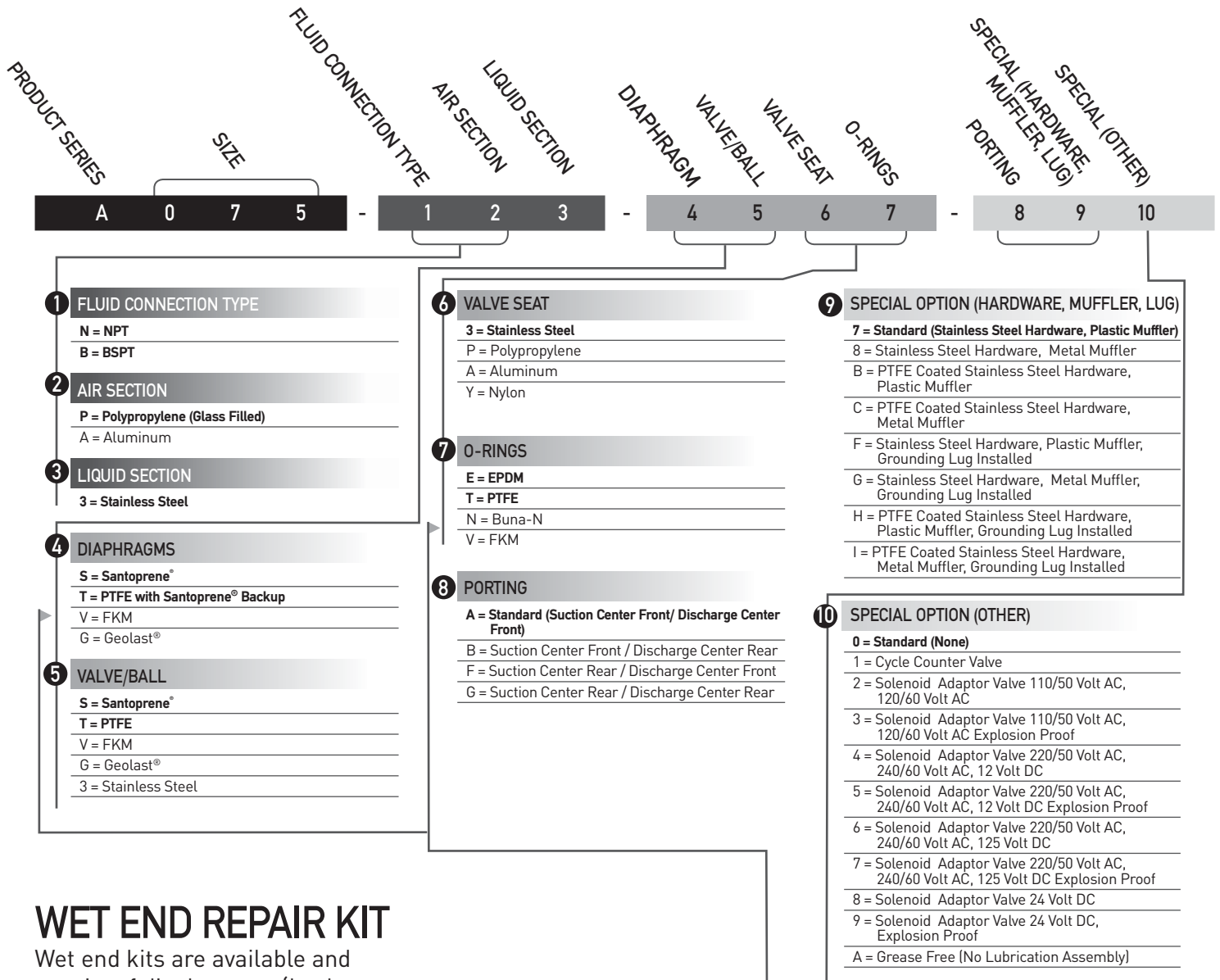

## AIR END REPAIR KIT

Air end repair kit contains pilot sleeve assembly and main air valve.

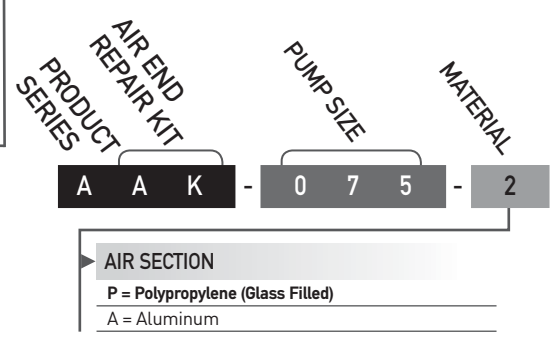
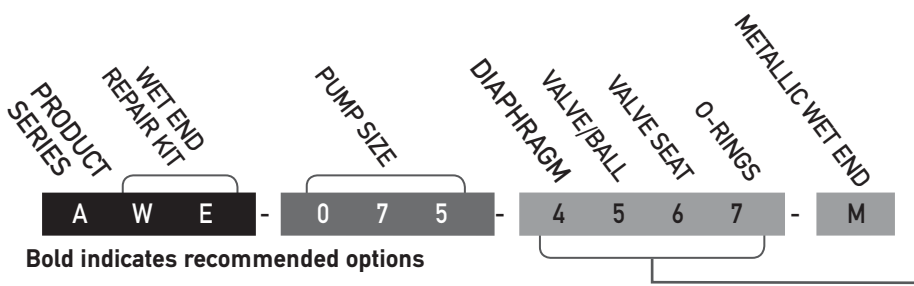

\* Solenoid Adaptor Valves only available on select pump models with polypropylene intermediate

# PRINCIPLES OF OPERATION

## HOW AN AIR OPERATED DOUBLE DIAPHRAGM PUMP WORKS

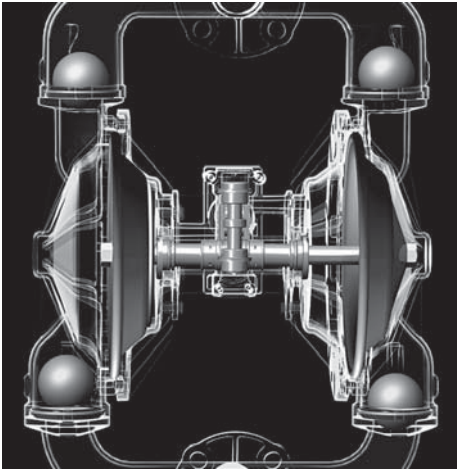

The air-valve directs pressurized air behind the diaphragm on the right, causing the diaphragm on the right to move outward (to the right).

Since both the right diaphragm and the left diaphragm are connected via a diaphragm rod, when the right diaphragm moves to the right, the left diaphragm (through the action of the diaphragm rod) moves to the right also.

When the diaphragm on the left side is moving to the right, it is referred to as suction stroke. When the left diaphragm is in its suction stroke, the left suction ball moves upward (opens) and the left discharge ball moves downward (closes). This action creates suction and draws liquid into the left side chamber.

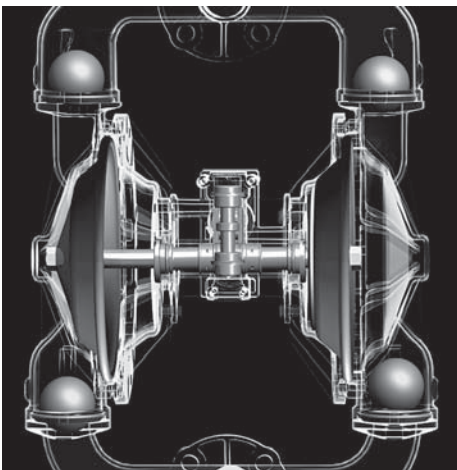

The air-valve directs pressurized air behind the left diaphragm, causing the left diaphragm to move outward (to the left).

Since both the left diaphragm and the right diaphragm are connected via a diaphragm rod, when the left diaphragm moves to the left, the right diaphragm (through the action of the diaphragm rod) moves to the left also.

When the diaphragm on the left side moves outward, the left discharge ball moves upward (opens) and the left suction ball moves downward (closes). This causes the liquid to leave the left side liquid outlet of the pump.

Simultaneously, the right diaphragm moves inward (to the left), which causes the right suction ball to open and the right discharge to close, which in turn causes suction, drawing liquid into the right chamber.

The process of alternating right suction / left discharge (and vice-versa) continues as long as compressed air is supplied to the pump.

# 3/4" PUMP DIMENSIONS

## ALUMINUM CENTER SECTION

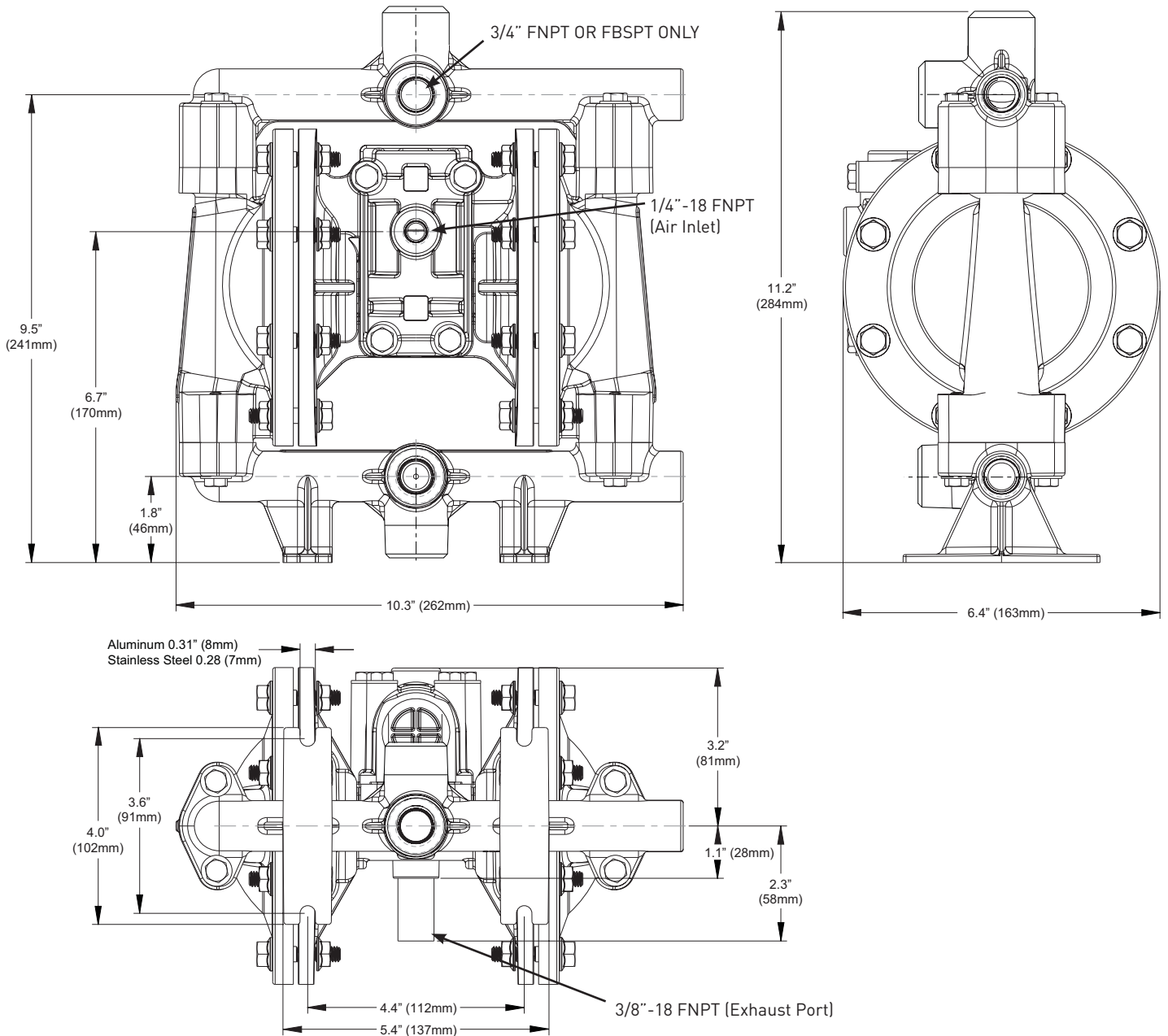

Note - Suction Center Front / Discharge Center Front are default ports.  
See part number matrix option code for additional porting options.



# 3/4" PUMP DIMENSIONS

## POLYPROPYLENE CENTER SECTION

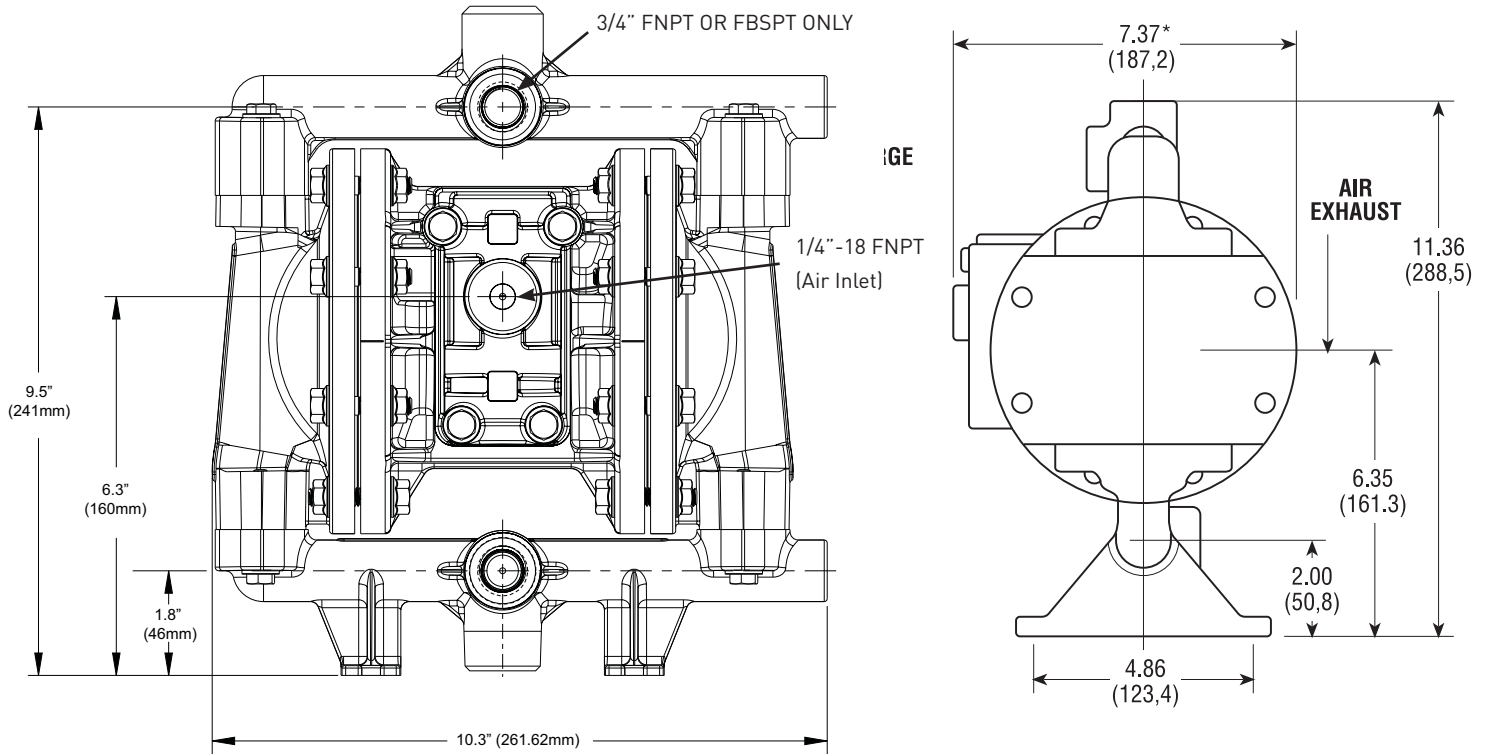

Note - Suction Center Front / Discharge Center Front are default ports.  
See part number matrix option code for additional porting options.



# PERFORMANCE CURVES

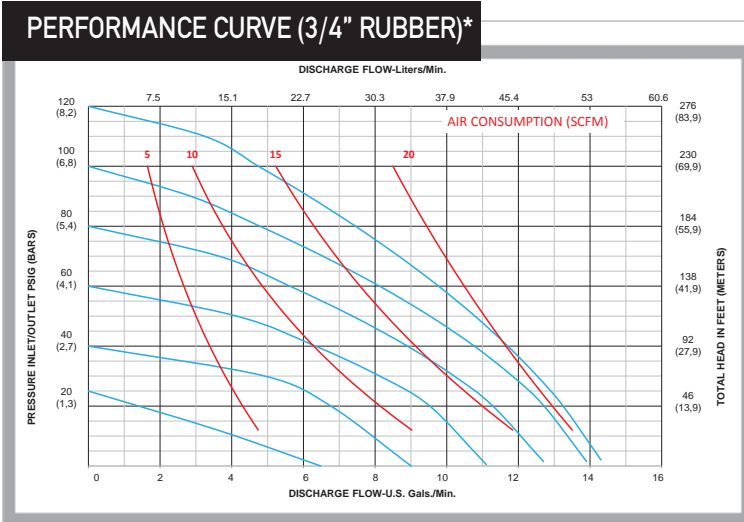

**Performance Specifications**

Max. Flow:	14 gpm [53.0 lpm]
Max. Air Pressure:	120 psi [8.3 bar]
Max. Solids:	1/8" [3.2 mm]
Max. Suction Lift Dry:	15 ft-H <sub>2</sub> O [4.5 m-H <sub>2</sub> O]
Max. Suction Lift Wet:	31 ft-H <sub>2</sub> O [9.4 m-H <sub>2</sub> O]
Weight:	AL-10 lbs [4.5 kg]/SS-20 lbs [9.1 kg]
Air Inlet:	1/4" FNPT
Liquid Inlet:	3/4" FNPT/BSPT
Liquid Outlet:	3/4" FNPT/BSPT
Height:	11.2" [284 mm]
Width:	10.3" [262 mm]
Depth:	6.4" [163 mm]**

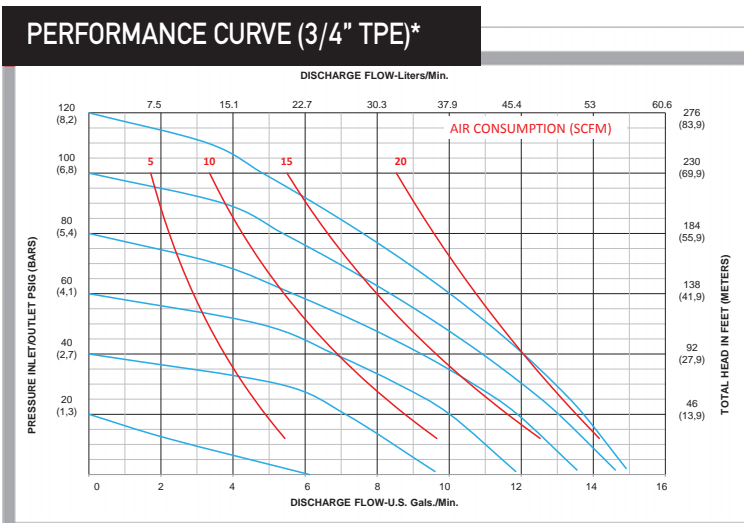

**Performance Specifications**

Max. Flow:	15 gpm [56.8 lpm]
Max. Air Pressure:	120 psi [8.3 bar]
Max. Solids:	1/8" [3.2 mm]
Max. Suction Lift Dry:	15 ft-H <sub>2</sub> O [4.5 m-H <sub>2</sub> O]
Max. Suction Lift Wet:	31 ft-H <sub>2</sub> O [9.4 m-H <sub>2</sub> O]
Weight:	AL-10 lbs [4.5 kg]/SS-20 lbs [9.1 kg]
Air Inlet:	1/4" FNPT
Liquid Inlet:	3/4" FNPT/BSPT
Liquid Outlet:	3/4" FNPT/BSPT
Height:	11.2" [284 mm]
Width:	10.3" [262 mm]
Depth:	6.4" [163 mm]**

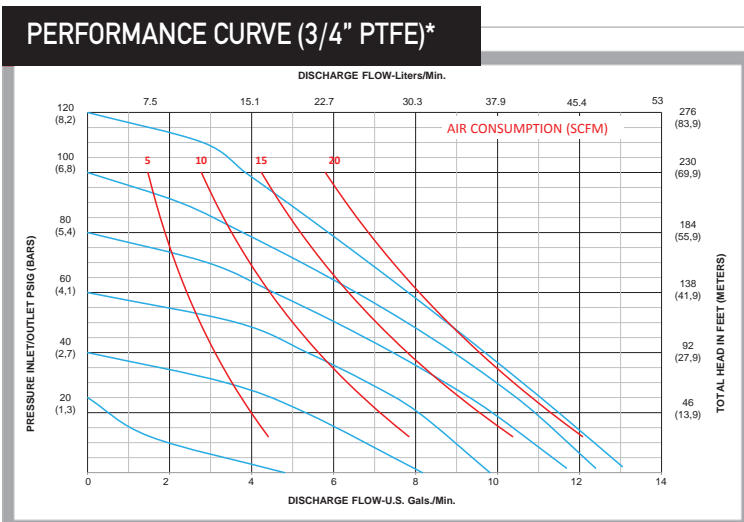

**Performance Specifications**

Max. Flow:	13 gpm [49.2 lpm]
Max. Air Pressure:	120 psi [8.3 bar]
Max. Solids:	1/8" [3.2 mm]
Max. Suction Lift Dry:	14 ft-H <sub>2</sub> O [4.3 m-H <sub>2</sub> O]
Max. Suction Lift Wet:	31 ft-H <sub>2</sub> O [9.4 m-H <sub>2</sub> O]
Weight:	AL-10 lbs [4.5 kg]/SS-20 lbs [9.1 kg]
Air Inlet:	1/4" FNPT
Liquid Inlet:	3/4" FNPT/BSPT
Liquid Outlet:	3/4" FNPT/BSPT
Height:	11.2" [284 mm]
Width:	10.3" [262 mm]
Depth:	6.4" [163 mm]**

\*Flow rates indicated on all three charts shown were determined by pumping water at flooded suction, using an aluminum intermediate fitted pump. For optimum life and performance, pumps should be specified so that daily operation parameters will fall in the center of the pump performance curve.  
 \*\*Polypropylene intermediate is 7.3" [185mm] deep.

# INSTALLATION, TROUBLESHOOTING AND MAINTENANCE

## INSTALLATION PIPING

Whenever possible ensure the pump is installed using the shortest possible pipe lengths with the minimum amount of pipe fittings. Ensure all piping is supported independent of the pump.

Suction and discharge piping should not be smaller than the connection size of the pump. When pumping liquids of high viscosity, larger piping may be used, in order to reduce frictional pipe loss.

Employ flexible hoses in order to eliminate the vibration caused by the pump. Mounting feet can also be used to reduce vibration effects.

All hoses should be reinforced, non-collapsible and be capable of high vacuum service. Ensure that all piping and hoses are chemically compatible with the process and cleaning fluid.

For processes where pulsation effects should be reduced, employ a pulsation dampener on the discharge side of the pump.

For self-priming applications, ensure all connections are airtight and the application is within the pumps dry-lift capability. Refer to product specifications for further details.

For flooded suction applications, install a gate valve on the suction piping in order to facilitate service.

For unattended flooded suction operation, it is recommended to pipe the exhaust air above the liquid source. In the event of a diaphragm failure this will reduce or eliminate the possibility of liquid discharging through the exhaust onto the ground.

## LOCATION

Ensure that the pump is installed in an accessible location, in order to facilitate future service and maintenance.

## AIR

Ensure that the air supply is sufficient for the volume of air required by the pump. Refer to product specifications for further details. For reliable operation, install a 5 micron air filter, air-valve and pressure regulator. Do not exceed the pumps maximum operating pressure of 120 psig.

## REMOTE OPERATION

Utilize a three way solenoid valve for remote operation. This ensures that air between the solenoid and the pump is allowed to “bleed off,” ensuring reliable operation. Liquid transfer volume is estimated by multiplying displacement per stroke times the number of strokes per minute.

## NOISE

Correct installation of the muffler reduces sound levels. Refer to product specifications for further details.

## SUBMERGED OPERATION

For submersible operation, pipe the air exhaust to atmosphere.

## GROUNDING THE PUMP

Loosen grounding screw and install a grounding wire. Tighten grounding screw. Wire size should be a 12 gauge wire or larger. Connect the other end of the wire to a true earth ground. Equipment must be grounded to achieve ATEX rating and it is recommended to configure the pump with a grounding lug option.

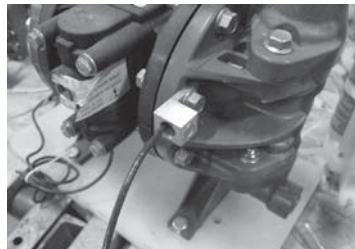

# SUGGESTED INSTALLATION

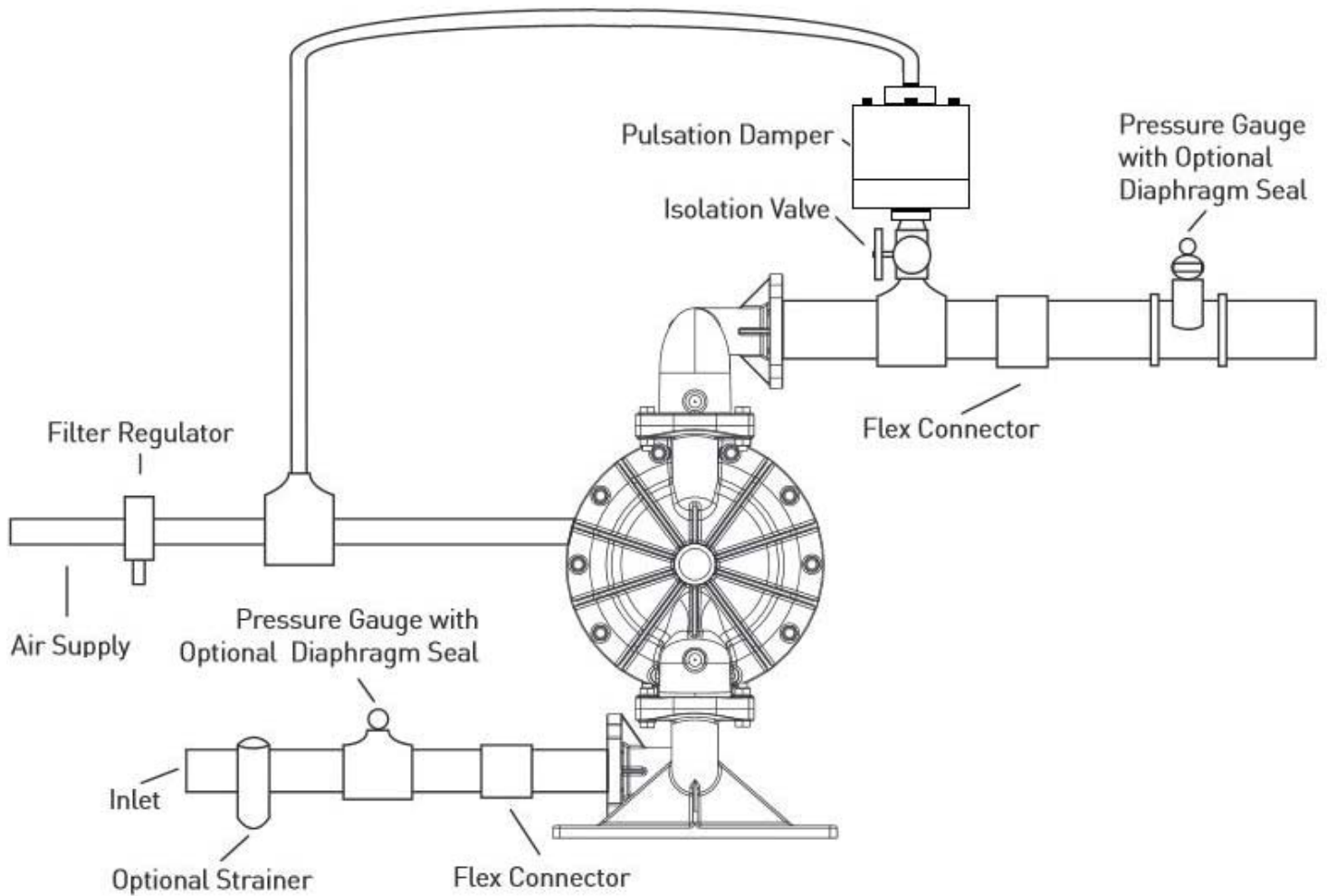

This illustration is a generic representation of an air operated double-diaphragm pump.

# TROUBLESHOOTING

## PROBLEM

## EFFECT/SOLUTION

### Pump Will Not Cycle

- Discharge line closed or plugged
- Discharge filter blocked
- Check valve stuck
- Air filter blocked
- Air supply valve closed
- Air supply hooked up to muffler side of pump
- Compressor not producing air or turned off
- Muffler iced or blinded
- Diaphragm ruptured
- Plant air supply line ruptured
- Air valve wear/debris
- Pilot sleeve wear/debris
- Diaphragm rod broken
- Diaphragm plate loose

### Pumped Fluid Coming Out of Muffler

- Diaphragm ruptured
- Diaphragm plate loose
- Inlet liquid pressure excessive (above 10 psig)

### Pump Cycles but no Flow

- Inlet strainer clogged
- Suction valve closed
- Suction line plugged
- No liquid in the suction tank
- Suction lift excessive
- Debris stuck in valves
- Excessive wear of check valves
- Air leak on suction side with suction lift

### Pump Cycles with Closed Discharge Valve

- Debris stuck in check valve
- Excessive wear of check valves

### Pump Running Slowly/Not Steady

- Air compressor undersized
- Leak in air supply
- Air-line, filter regulator or needle valve undersized
- Muffler partially iced or blinded
- Air valve gasket leak or misalignment
- Air valve wear/debris
- Pilot sleeve wear/debris
- Liquid fluid filter blocked
- Pump may be cavitating, reduce speed of operation
- Suction strainer clogged

### Pump Will Not Prime

- Air leak in suction pipe
- Air leak in pump manifold connections
- Suction strainer and lines clogged
- Excessive lift conditions
- Check valve wear
- Debris in check valve

## OPERATION

The Air-Operated Double Diaphragm Pump requires a minimum of 20 psig of air to operate, with some variation according to diaphragm material. Increasing the air pressure results in a more rapid cycling of the pump and thus a higher liquid flow rate. In order to not exceed 120 psig of inlet air pressure, and for accurate control of the pump, it is suggested to use a pressure regulator on the air inlet.

An alternate means of controlling the flow-rate of the pump is to use an inlet air valve and partially open or close accordingly. When the air valve is completely in the closed position, the pump will cease to operate.

A third method of controlling the flow rate of the pump is to use a liquid discharge valve. Closing the liquid discharge valve will cause a decrease in the flow rate since the pump will operate against a higher discharge pressure.

Solenoid control of the inlet air may also be used in order to facilitate remote operation. A three way solenoid valve is recommended, in order to allow the air to “bleed off” between the solenoid and the pump.

Do not use valves for flow control on the suction side of the pump. (Closing or partially closing a liquid suction valve restrict the suction line and may cause damage to the diaphragms.) Suction strainers may be employed to reduce or eliminate larger solids, but routine maintenance is necessary in order to prevent a restriction on the suction.

## MAINTENANCE

Due to the unique nature of each application, periodic inspection of the pump is the best method to determine a proper maintenance schedule. A record should be kept of all repairs made to an installed pump. This will serve as the best predictor of future maintenance.

Typical maintenance involves replacing of “wear-parts” such as the diaphragms, balls, valve seats and O-rings. Proper maintenance can ensure trouble-free operation of the pump. Refer to repair and assembly instructions for further details.

 **WARNING** Maintenance must not be performed when a hazardous atmosphere is present.

## MAINTENANCE SCHEDULE

### WEEKLY (OR DAILY)

Make a visual check of the pump. If pumped fluid is leaking out of the pump, pipe fittings or muffler turn off pump and schedule maintenance.

### EVERY THREE MONTHS

Inspect fasteners and tighten any loose fasteners to recommended torque settings.

Schedule pump service based on pump’s service history.

# REPAIR AND ASSEMBLY

## PUMP WET END REMOVAL

### TOOLS NEEDED

- 1) One Wrench, 7/16 Inch
- 2) Two Wrenches, 1/2 Inch
- 3) Two Wrenches, 3/4 Inch
- 4) One Screwdriver, Slotted Head

**⚠ WARNING** Prior to servicing the pump, ensure that the air and fluid lines are closed and disconnected. While wearing personal protective equipment, flush, drain and process liquid from the pump in a safe manner.

**⚠ WARNING** Maintenance must not be performed when a hazardous atmosphere is present.

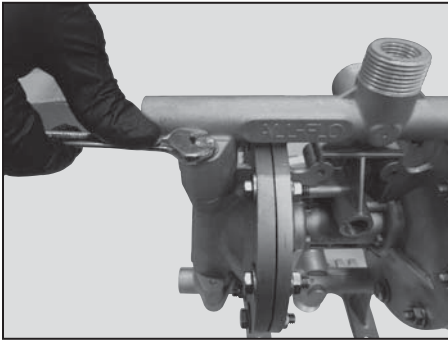

#### STEP 1

Using the 7/16 inch wrench remove four "Hex-Head Cap Screws (1/4"-20 x 1-3/4)" and four "Flat Washers (1/4)" from the "Discharge Manifold"

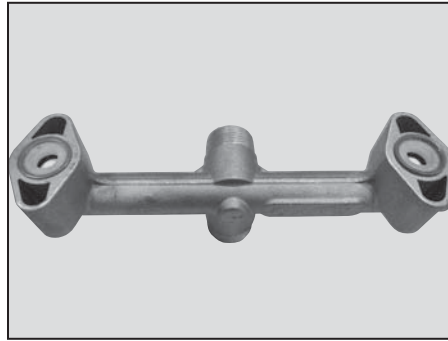

#### STEP 2

Remove the "Discharge Manifold".

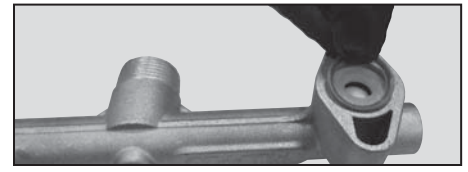

#### STEP 3

Remove the "O-Ring", "Valve Seat" and "Ball" from the "Discharge Manifold".

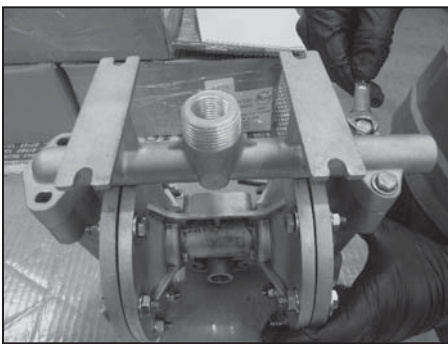

#### STEP 4

Using the 7/16 inch wrench remove four "Hex-Head Cap Screws (1/4"-20 x 1-3/4)" and four "Flat Washers (1/4)" from the "Suction Manifold".

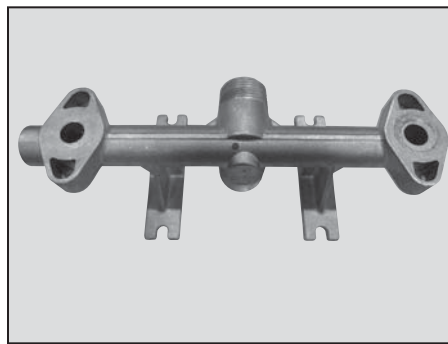

#### STEP 5

Remove the "Suction Manifold".

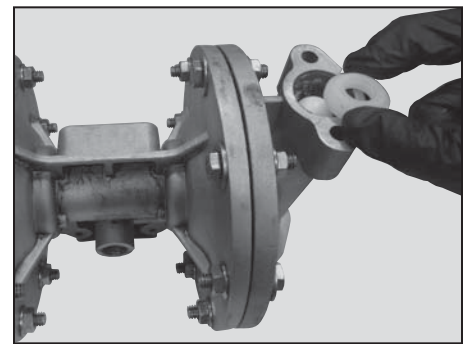

#### STEP 6

Remove the "O-Ring", "Valve Seat" and "Ball" from the "Suction Manifold".



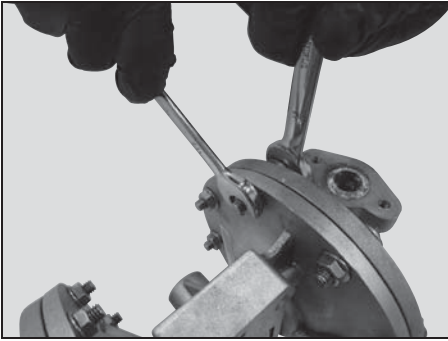

### STEP 7

In order to remove "Outer Chambers", using two 1/2 inch wrenches, remove eight "Hex Head Cap Screws (5/16"-18 x 1-3/4")", eight "Flat and Lock Washers (5/16")" and eight "Hex Flange Nuts (5/16"-18)" from each side.

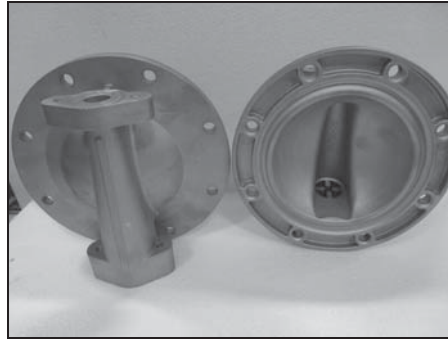

### STEP 8

Remove both "Outer Chambers" from the "Intermediate".

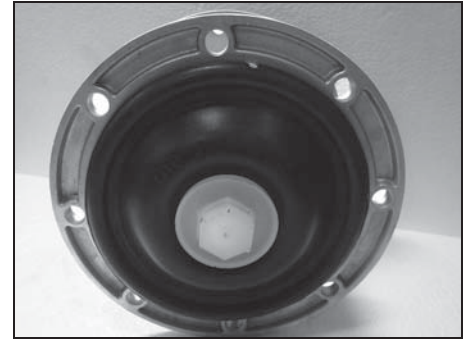

### STEP 9

Using two 3/4 Inch wrenches, remove "Outer Diaphragm Plate", "Diaphragm", "Inner Diaphragm Plate" and "Flat Washer (1/4")" from one side of the pump.

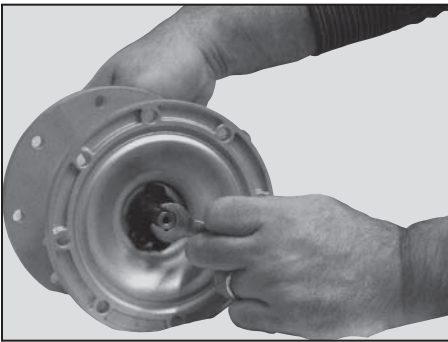

### STEP 10

Placing the 3/4 inch wrench on the remaining "Outer Diaphragm Plate", and the 7/16 inch wrench on the "Diaphragm Rod Assembly", remove the remaining "Outer Diaphragm Plate", "Diaphragm", "Inner Diaphragm Plate" and "Flat Washer (1/4")" from the other side of the pump.

## PUMP WET END ASSEMBLY

To assemble the wet end of the pump, reverse the order of disassembly. Ensure all hardware is fastened in accordance with torque specifications (see page 19). Inverting one of the diaphragms during reassembly will facilitate ease of assembly.



# REPAIR AND ASSEMBLY

## AIR VALVE REMOVAL

### TOOLS NEEDED

- 1) One Wrench,  $\frac{7}{16}$  Inch
- 2) One Pick, General Purpose
- 3) One Pair of Pliers

**⚠ WARNING** Prior to servicing the pump, ensure that the air and fluid lines are closed and disconnected. While wearing personal protective equipment, flush, drain and process liquid from the pump in a safe manner.

**⚠ WARNING** Maintenance must not be performed when a hazardous atmosphere is present.

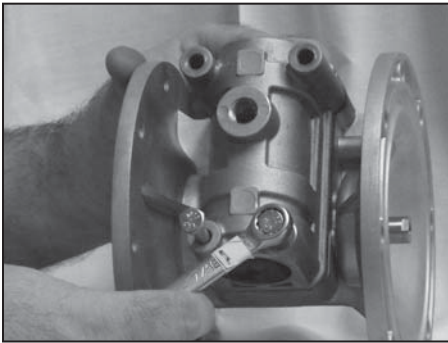

#### STEP 1

Using the  $\frac{7}{16}$  inch wrench, remove four "Hex Head Cap Screws (1/4" - 20)", four "Lock Washers (1/4")" and four "Flat Washers (1/4")".



#### STEP 2

Remove the main "Air-Valve Assembly" from the pump.

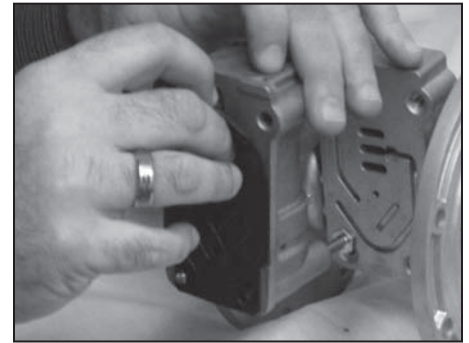

#### STEP 3

Remove the "Air-Valve Gasket" from the main "Air-Valve Assembly".

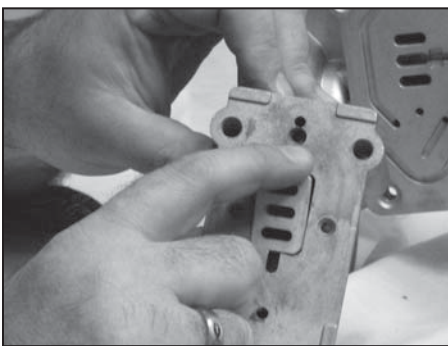

#### STEP 4

Remove the "Shuttle Plate" from the main "Air-Valve Assembly".

Note: The smooth shiny side of the shuttle plate should be toward the shuttle car.

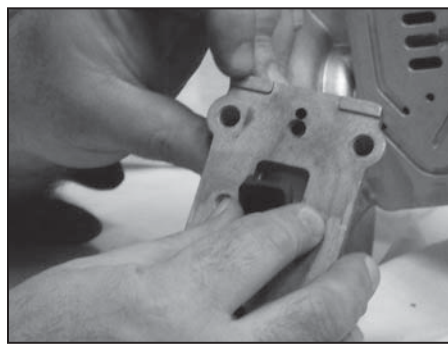

#### STEP 5

Remove the "Shuttle" from the main "Air-Valve Assembly".



#### STEP 6

Using the pair of pliers, remove the "Air Valve End Plug" from the main "Air-Valve Assembly".

Ensure the "O-Ring" is installed when reassembling.



### STEP 7

Remove the "Air Valve Spool" from the main "Air-Valve Assembly".

Note: Insert larger chamfer first. The smaller chamfer is to be on the plug side.

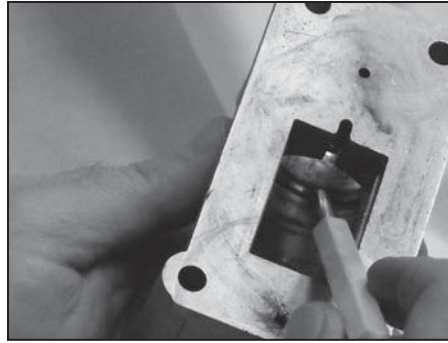

### STEP 8

Using the pick, remove the "Lip Seal (Air Valve)" from the main "Air-Valve Assembly".

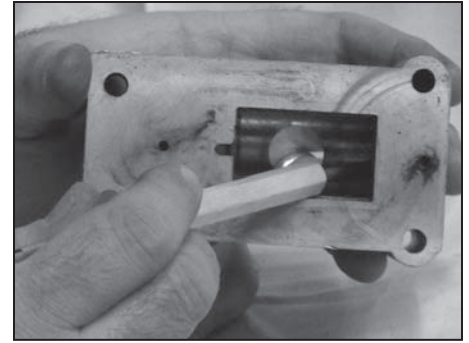

### STEP 9

Using the pick, remove the second "Lip Seal (Air Valve)" from the main "Air-Valve Assembly".

## AIR VALVE ASSEMBLY

To assemble the air valve, reverse the order of disassembly. During assembly, ensure that the open side of the lip-seals are both facing each other inward. Install the shuttle plate with the smooth/shiny side toward the shuttle car. Lubrication of the air valve assembly, with a non-synthetic lubricant, is recommended. Magna-Lube or Magna-Plate are recommended for assembly lubrication (see detailed parts list for ordering information).

Note that if the lip-seals are installed incorrectly, they will be unable to rotate. Insert the spool, larger chamfer first, smaller chamfer to be on the plug side (longer piston/smaller boss), ensure O-ring is installed and then the air-valve end plug into position.

# REPAIR AND ASSEMBLY

## PILOT VALVE REMOVAL

### TOOLS NEEDED

- 1) One Screwdriver, #2 Phillips
- 2) Two Wrenches,  $\frac{7}{16}$  Inch

**⚠ WARNING** Prior to servicing the pump, ensure that the air and fluid lines are closed and disconnected. While wearing personal protective equipment, flush, drain and process liquid from the pump in a safe manner.

**⚠ WARNING** Maintenance must not be performed when a hazardous atmosphere is present.

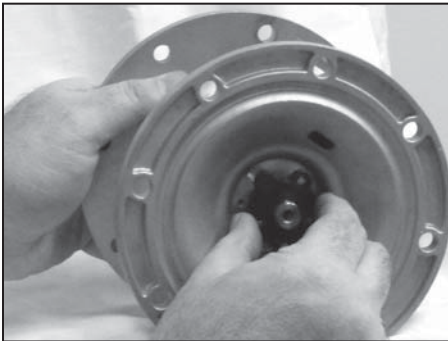

#### STEP 1

Using the screwdriver, remove three "Phillips Pan-Head Screws (#6-32)" in order to remove the "Retaining Plate". Repeat for both sides of the pump.



#### STEP 2

Remove the diaphragm rod and the pilot sleeve assembly from the "Intermediate".

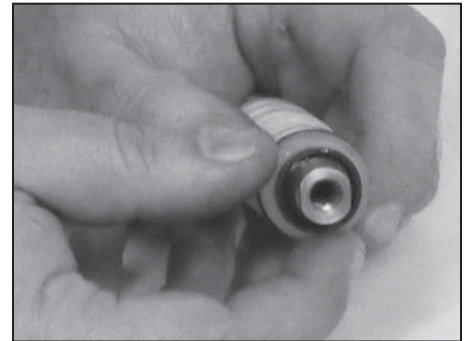

#### STEP 3

Remove both "Lip Seals (Diaphragm Rod)" and both "End Spacers (Pilot Sleeve)" from the pilot sleeve assembly. Remove both "O-Rings (End Spacer)" from both "End Spacers (Pilot Sleeve)".

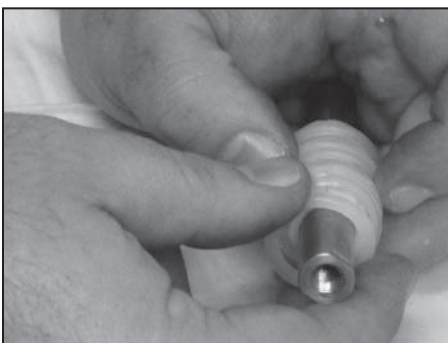

#### STEP 4

Remove three "Inner Spacers (Pilot Sleeve)" and four "O-Rings (Pilot Sleeve)" from the pilot sleeve assembly.



#### STEP 5

Using two  $\frac{7}{16}$  inch wrenches, disassemble the "Diaphragm Rod Assembly" into its two parts.  
Note: They are installed with thread locker.



#### STEP 6

Remove the "Pilot Sleeve" from the disassembled "Diaphragm Rod Assembly".

# PILOT VALVE ASSEMBLY

To assemble the pilot valve, reverse the order of disassembly. Should process fluid have contact with the pilot valve O-rings, they should be replaced as swelling may occur and cause irregular operation. During assembly, ensure that the open side of the lip-seals are facing outward. Lubrication of the pilot sleeve assembly, with a non-synthetic lubricant, is recommended in order to facilitate re-assembly into the intermediate. Magna-Lube or Magna-Plate are recommended for assembly lubrication [see detailed parts list for ordering information].

## TORQUE SPECIFICATION CHART

### RECOMMENDED TORQUE SPECIFICATIONS

	1/2" and 3/4" Pumps	Wrench Size
Manifold Bolts	78 in-lbs (8.8 N-m)	7/16"
Chamber Bolts	85 in-lbs (9.6 N-m)	1/2"
Air Valve Bolts	40 in-lbs (4.5 N-m)	7/16"
Diaphragm plate	70 in-lbs (7.9 N-m)	3/4"
Diaphragm plate (PTFE)	70 in-lbs (7.9 N-m)	3/4"

# EXPLODED VIEW & PARTS LIST

## ALUMINUM AND STAINLESS STEEL PUMPS WITH ALUMINUM CENTER SECTION (A075-\*A\*-\*\*\*\*-\*\*\*)

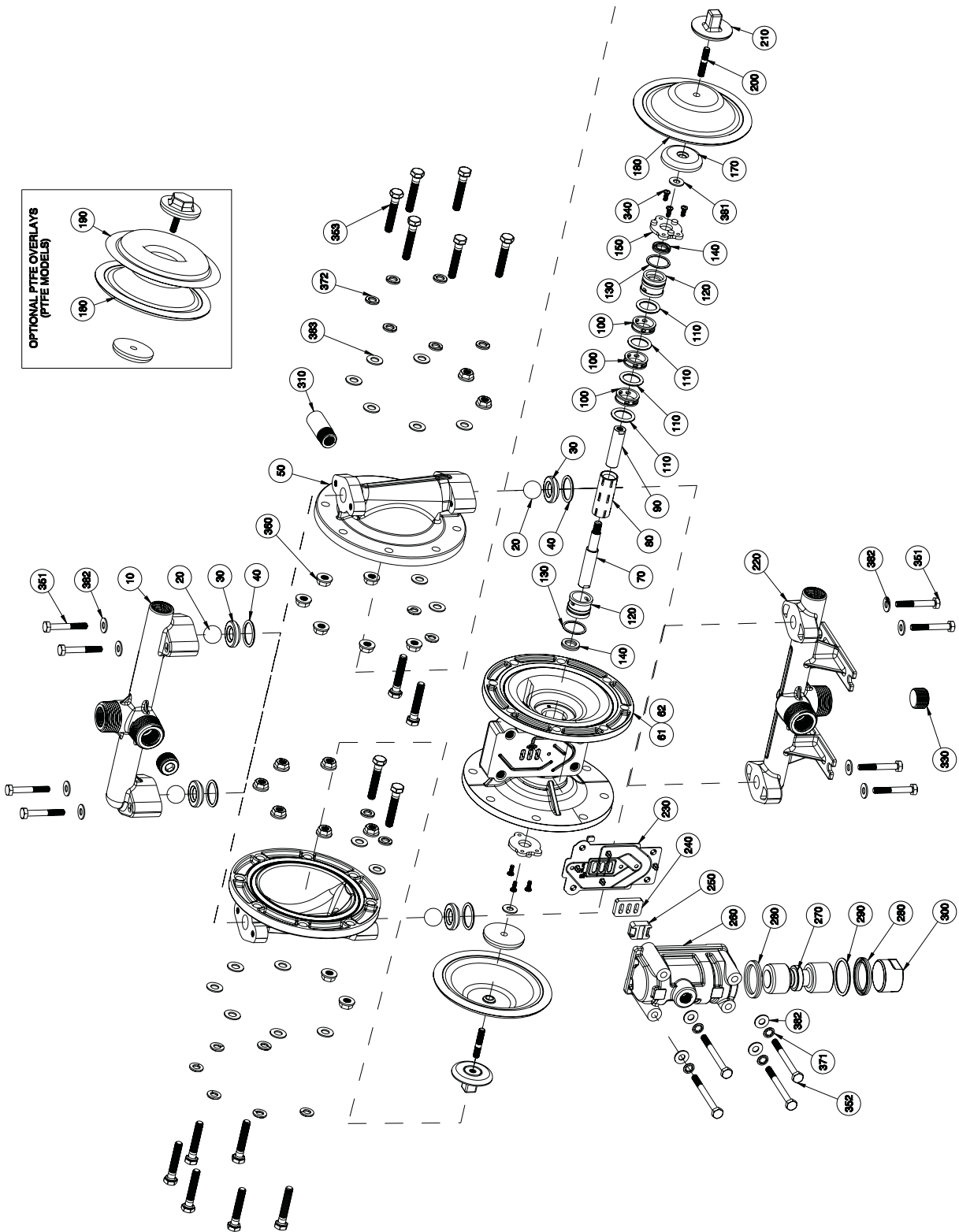

# PARTS LIST - ALUMINUM AND STAINLESS STEEL PUMPS WITH ALUMINUM CENTER SECTION (A075-\*A\*-\*\*\*\*-\*\*\*)

ITEM	DESCRIPTION	QTY	PUMP MODEL	PART NO.	MATERIAL
10	DISCHARGE MANIFOLD	1	A075-N*A-****-0**	11329-A075-20-N	Aluminum
			A075-B*A-****-0**	11329-A075-20-B	Aluminum
			A075-N*3-****-0**	11329-A075-26-N	Stainless Steel
			A075-B*3-****-0**	11329-A075-26-T	Stainless Steel
20	BALL	4	A075-***_V**_***	11000-13	FKM
			A075-***_G**_***	11000-19	Geolast®
			A075-***_C**_***	11000-23	Santoprene®
			A075-***_3**_***	11000-26	Stainless Steel
			A075-***_T**_***	11000-45	PTFE
30	VALVE SEAT	4	A075-***_**A*_***	10900-20	Aluminum
			A075-***_**3*_***	10900-26	Stainless Steel
			A075-***_**P*_***	10900-40	Polypropylene
			A075-***_**Y*_***	10900-42	Nylon
			A075-***_**K*_***	10900-56	PVDF
40	O-RING (VALVE SEAT)	4	A075-***_***N_***	11904-11	Nitrile
			A075-***_***V_***	11904-13	FKM
			A075-***_***E_***	11904-15	EPDM
			A075-***_***T_***	11904-17	PTFE
50	OUTER CHAMBER	2	A075-**A-****_***	10720-20	Aluminum
			A075-**3-****_***	10720-26	Stainless Steel
61 & 62	INTERMEDIATE	1	A075-*A*-****_***	11527-20	Aluminum
70 & 90	DIAPHRAGM ROD ASSEMBLY	1	ALL MODELS	33000-00	Stainless Steel
80	PILOT SLEEVE	1	ALL MODELS	10105-31 Δ	Acetel
100	INNER SPACER (PILOT SLEEVE)	3	ALL MODELS	10203-40 Δ	Polypropylene
110	O-RING (PILOT SLEEVE)	4	ALL MODELS	11920-16 Δ	Urethane
120	END SPACER (PILOT SLEEVE)	2	ALL MODELS	10204-40 Δ	Polypropylene
130	O-RING (END SPACER)	2	ALL MODELS	11923-11 Δ	Nitrile
140	LIP SEAL (DIAPHRAGM ROD)	2	ALL MODELS	12000-76 Δ	Nitrile
150	RETAINING PLATE	2	ALL MODELS	12708-54	Nylon
160	N/A				
170	INNER DIAPHRAGM PLATE	2	ALL MODELS	11100-40	Polypropylene
180	DIAPHRAGM	2	A075-***_V***_***	10600-13	FKM
			A075-***_G***_***	10600-19	Geolast®
			A075-***_N***_***	10600-21	Nitrile
			A075-***_S***_***	10600-23	Santoprene®
			A075-***_T***_***	10600-23	Santoprene®
190	OVERLAY (OPTIONAL)	2	A075-***_T***_***	11400-59	PTFE
200 & 210	OUTER DIAPHRAGM PLATE	2	A075-**A-****_***	11208-20	Aluminum
			A075-**3-****_***	11208-26	Stainless Steel
220	SUCTION MANIFOLD	1	A075-N*A-****_***	11328-A075-20-N	Aluminum
			A075-B*A-****_***	11328-A075-20-B	Aluminum
			A075-N*3-****_***	11328-A075-26-N	Stainless Steel
			A075-B*3-****_***	11328-A075-26-T	Stainless Steel
230	AIR VALVE GASKET	1	ALL MODELS	12126-19 ‡	Nitrile
240	SHUTTLE PLATE	1	ALL MODELS	10416-77 ‡	Ceramic
250	SHUTTLE	1	ALL MODELS	10415-00 ‡	Special
260	AIR VALVE BODY	1	A075-*A*-****_***	42001-20 ‡	Aluminum
270	AIR VALVE SPOOL	1	ALL MODELS	10480-31 ‡	Acetel
280	LIP SEAL (AIR VALVE)	2	ALL MODELS	12003-76 ‡	Nitrile
290	O-RING (AIR VALVE END PLUG)	1	ALL MODELS	11913-11 ‡	Nitrile



# PARTS LIST - ALUMINUM AND STAINLESS STEEL PUMPS WITH ALUMINUM CENTER SECTION (A075-\*A\*-\*\*\*\*-\*\*\*)

ITEM	DESCRIPTION	QTY	PUMP MODEL	PART NO.	MATERIAL
300	AIR VALVE END PLUG	1	A075-*A*-****-***	11706-20 ‡	Aluminum
310	MUFFLER MUFFLER (METAL)	1	ALL MODELS Optional	13008-00 13002-00	Standard Metal
320	N/A				
340	PAN-HEAD MACH SCREW (#6-32 x 7/16)	6	A075-**A-****-***	12585-26	Stainless Steel
351	HEX HEAD CAP SCREW (1/4"-20 x 1-3/4")	8	A075-**A-****-*0* A075-**3-****-*0*	12500-25 12500-26	Plated Steel Stainless Steel
352	HEX HEAD CAP SCREW (1/4"-20 x 2-3/4")	4	A075-**AA-****-*0* A075-**A3-****-*0*	12576-25 12576-26	Plated Steel Stainless Steel
353	HEX HEAD CAP SCREW (5/16-18 x 1-3/4")	16	A075-**A-****-*0* A075-**3-****-*0*	12503-25 12503-26	Plated Steel Stainless Steel
360	HEX FLANGE NUT (5/16"-18)	16	A075-**A-****-*0* A075-**3-****-*0*	12608-25 12608-26	Plated Steel Stainless Steel
371	LOCK WASHER (1/4")	4	A075-**A-****-*0* A075-**3-****-*0*	12350-25 12350-26	Plated Steel Stainless Steel
372	WASHER, SPLIT LOCK (5/16")	16	A075-**A-****-*0* A075-**3-****-*0*	12313-25 12313-26	Plated Steel Stainless Steel
381	WASHER (1/4")	2	ALL MODELS	12300-26	Stainless Steel
382	WASHER (1/4")	12 12	A075-**A-****-*0* A075-**3-****-*0*	12300-25 12300-26	Plated Steel Stainless Steel
383	WASHER (5/16")	16	A075-**A-****-*0* A075-**3-****-*0*	12310-25 12310-26	Plated Steel Stainless Steel
390	N/A				
400	GROUNDING LUG (NOT SHOWN)	1	OPTIONAL	13481-20	Aluminum
	Magnalube® .75 oz. (As Required)		ALL MODELS	13404-00	Grease

\* Any Character

‡, Δ Only sold as part of assembly

ASSEMBLY PART NUMBERS	PUMP MODEL	PART NO.	MATERIAL
‡ AIR VALVE ASSEMBLY 230, 240, 250, 260, 270, 280, 290, 300	A075-*A*-****-***	AMK-075-A	Various
Δ PILOT SIEVE ASSEMBLY 80, 100, 110, 120, 130, 140	A075-*A*-****-***	APK-075-A	Various



# EXPLODED VIEW & PARTS LIST

## ALUMINUM AND STAINLESS STEEL PUMPS WITH PLASTIC CENTER SECTION (A075-\*P\*-\*\*\*\*-\*\*\*)

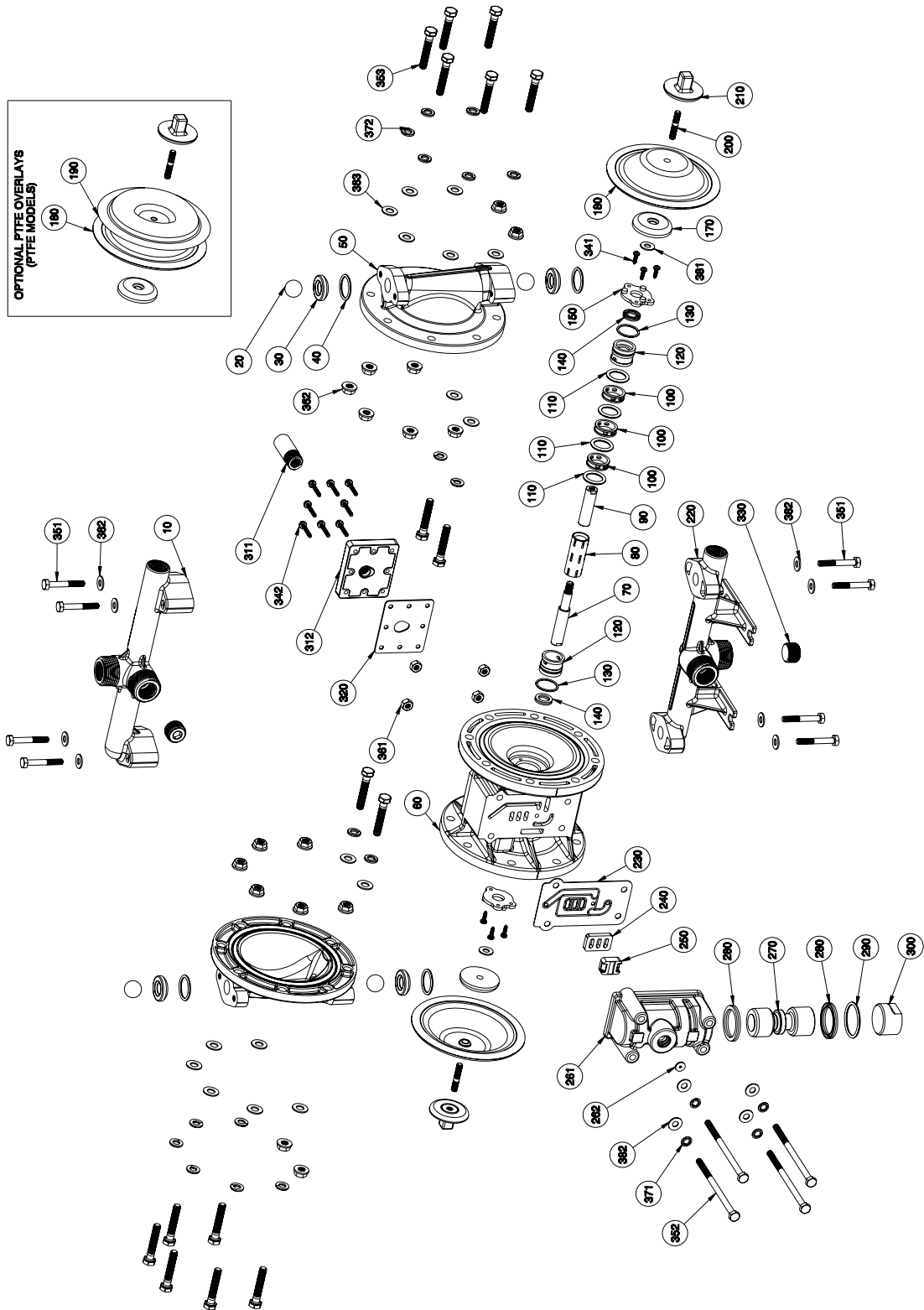

# PARTS LIST - ALUMINUM AND STAINLESS STEEL PUMPS WITH PLASTIC CENTER SECTION (A075-\*P\*-\*-\*-\*\*\*)

ITEM	DESCRIPTION	QTY	PUMP MODEL	PART NO.	MATERIAL
10	DISCHARGE MANIFOLD	1	A075-N*A-*-*-0**	11329-A075-20-N	Aluminum
			A075-B*A-*-*-0**	11329-A075-20-B	Aluminum
			A075-N*3-*-*-0**	11329-A075-26-N	Stainless Steel
			A075-B*3-*-*-0**	11329-A075-26-T	Stainless Steel
20	BALL	4	A075-*-*-*V**-*	11000-13	FKM
			A075-*-*-*G**-*	11000-19	Geolast®
			A075-*-*-*S**-*	11000-23	Santoprene®
			A075-*-*-*3**-*	11000-26	Stainless Steel
			A075-*-*-*T**-*	11000-45	PTFE
30	VALVE SEAT	4	A075-*-*-*A**-*	10900-20	Aluminum
			A075-*-*-*3**-*	10900-26	Stainless Steel
			A075-*-*-*P**-*	10900-40	Polypropylene
			A075-*-*-*Y**-*	10900-42	Nylon
			A075-*-*-*K**-*	10900-56	PVDF
40	O-RING (VALVE SEAT)	4	A075-*-*-*N**-*	11904-11	Nitrile
			A075-*-*-*V**-*	11904-13	FKM
			A075-*-*-*E**-*	11904-15	EPDM
			A075-*-*-*T**-*	11904-17	PTFE
50	OUTER CHAMBER	2	A075-*A-*-*-**	10720-20	Aluminum
			A075-*3-*-*-**	10720-26	Stainless Steel
60	INTERMEDIATE	1	A075-*P*-*-*-**	11521-60	Polypropylene
70 & 90	DIAPHRAGM ROD ASSEMBLY	1	ALL MODELS	33000-00	Stainless Steel
80	PILOT SLEEVE	1	ALL MODELS	10105-31 Δ	Acetel
100	INNER SPACER (PILOT SLEEVE)	3	ALL MODELS	10203-40 Δ	Polypropylene
110	O-RING (PILOT SLEEVE)	4	ALL MODELS	11920-16 Δ	Urethane
120	END SPACER (PILOT SLEEVE)	2	ALL MODELS	10204-40 Δ	Polypropylene
130	O-RING (END SPACER)	2	ALL MODELS	11923-11 Δ	Nitrile
140	LIP SEAL (DIAPHRAGM ROD)	2	ALL MODELS	12000-76 Δ	Nitrile
150	RETAINING PLATE	2	ALL MODELS	12708-54	Nylon
160	N/A				
170	INNER DIAPHRAGM PLATE	2	ALL MODELS	11100-40	Polypropylene
180	DIAPHRAGM	2	A075-*-*-*V**-*	10600-13	FKM
			A075-*-*-*G**-*	10600-19	Geolast®
			A075-*-*-*N**-*	10600-21	Nitrile
			A075-*-*-*S**-*	10600-23	Santoprene®
			A075-*-*-*T**-*	10600-23	Santoprene®
190	OVERLAY (OPTIONAL)	2	A075-*-*-*T**-*	11400-59	PTFE
200 & 210	OUTER DIAPHRAGM PLATE	2	A075-*A-*-*-**	11208-20	Aluminum
			A075-*3-*-*-**	11208-26	Stainless Steel
220	SUCTION MANIFOLD	1	A075-N*A-*-*-0**	11328-A075-20-N	Aluminum
			A075-B*A-*-*-0**	11328-A075-20-B	Aluminum
			A075-N*3-*-*-0**	11328-A075-26-N	Stainless Steel
			A075-B*3-*-*-0**	11328-A075-26-T	Stainless Steel
230	AIR VALVE GASKET	1	ALL MODELS	12116-19 ‡	Nitrile
240	SHUTTLE PLATE	1	ALL MODELS	10416-77 ‡	Ceramic
250	SHUTTLE	1	ALL MODELS	10415-00 ‡	Special
261 & 262	AIR VALVE BODY	1	A075-*P*-*-*-**	11614-60 ‡	Polypropylene
270	AIR VALVE SPOOL	1	ALL MODELS	10480-31 ‡	Acetel
280	LIP SEAL (AIR VALVE)	2	ALL MODELS	12003-76 ‡	Nitrile
290	O-RING (AIR VALVE END PLUG)	1	ALL MODELS	11913-11 ‡	Nitrile

# PARTS LIST - ALUMINUM AND STAINLESS STEEL PUMPS WITH PLASTIC CENTER SECTION (A075-\*P\*\_\*\*\*\*\_\*\*\*)

ITEM	DESCRIPTION	QTY	PUMP MODEL	PART NO.	MATERIAL
300	AIR VALVE END PLUG	1	A075-*P*_****_***	11703-60 ‡	Polypropylene
311	MUFFLER MUFFLER (METAL)	1	ALL MODELS Optional	13008-00 13002-00	Standard Metal
312	MUFFLER PLATE	1	A075-*P*_****_***	13111-60	Polypropylene
320	MUFFLER PLATE GASKET	1	A075-*P*_****_***	12117-19	Nitrile
341	SCREW, SELF-TAP (#6 X 1/2")	6	A075-*P*_****_***	12510-26	Stainless Steel
342	SCREW, SLOTTED HEAD SELF-TAP (1")	8	A075-*P*_****_***	12525-26	Stainless Steel
351	HEX HEAD CAP SCREW (1/4"-20 x 1-3/4")	8	A075-**A-****_0* A075-**3-****_0*	12500-25 12500-26	Plated Steel Stainless Steel
352	HEX HEAD CAP SCREW (1/4"-20 x 4-1/2")	4	A075-*PA-****_0* A075-*P3-****_0*	12513-25 12513-26	Plated Steel Stainless Steel
353	HEX HEAD CAP SCREW (5/16-18 x 1-3/4")	16	A075-**A-****_0* A075-**3-****_0*	12503-25 12503-26	Plated Steel Stainless Steel
361	HEX NUT (1/4"-20)	4	A075-*PA-****_0* A075-*P3-****_0*	12600-25 12600-26	Plated Steel Stainless Steel
362	HEX FLANGE NUT (5/16"-18)	16	A075-**A-****_0* A075-**3-****_0*	12608-25 12608-26	Plated Steel Stainless Steel
371	LOCK WASHER (1/4")	4	A075-**A-****_0* A075-**3-****_0*	12350-25 12350-26	Plated Steel Stainless Steel
372	WASHER, SPLIT LOCK (5/16")	16	A075-**A-****_0* A075-**3-****_0*	12313-25 12313-26	Plated Steel Stainless Steel
381	WASHER (1/4")	2	ALL MODELS	12300-26	Stainless Steel
382	WASHER (1/4")	12	A075-**A-****_0* A075-**3-****_0*	12300-25 12300-26	Plated Steel Stainless Steel
383	WASHER (5/16")	16	A075-**A-****_0* A075-**3-****_0*	12310-25 12310-26	Plated Steel Stainless Steel
390	N/A				
400	GROUNDING LUG (NOT SHOWN)	1	OPTIONAL	13481-20	Aluminum
	Magnalube® .75 oz. (As Required)		ALL MODELS	13404-00	Grease
* Any Character					
‡ , Δ Only sold as part of assembly					

ASSEMBLY PART NUMBERS	PUMP MODEL	PART NO.	MATERIAL
‡ AIR VALVE ASSEMBLY 230, 240, 250, 261, 262, 270, 280, 290, 300	A075-*P*_****_***	AMK-075-P	Various
Δ PILOT SIEVE ASSEMBLY 80, 100, 110, 120, 130, 140	A075-*P*_****_***	APK-075-P	Various

# ELASTOMERS

## WETTED ELASTOMERS

### BUNA-N (NITRILE)

is a general purpose elastomer used with water and many oils. Temperature range 10°F to 180°F (-12°C to 82°C).

### GEOLAST®

is an injection molded thermoplastic material with characteristics similar to Nitrile. Has excellent abrasion resistance. Temperature range 10°F to 180°F (-12°C to 82°C).

### EPDM

is a general purpose elastomer with good resistance to many acids and bases. Temperature range -40°F to 280°F (-40°C to 138°C).

### SANTOPRENE®

is an injection molded material with characteristics similar to EPDM. Has excellent abrasion resistance. Temperature range -40°F to 225°F (-40°C to 107°C).

### FKM

is an elastomer with good corrosion resistance to a wide variety of chemicals. Temperature range -40°F to 350°F (-40°C to 177°C).

### PTFE (POLYTETRAFLUOROETHYLENE)

is a thermoplastic polymer that is inert to most chemicals. Temperature range 40°F to 220°F (4°C to 104°C).

Most of the above elastomers are available in FDA approved formulations.

Geolast® is a registered trademark of ExxonMobil Chemical Co.

Santoprene® is a registered trademark of ExxonMobil Chemical Co.

Hytrel® is a registered trademark of DuPont Performance Elastomers L.L.C.

Magnalube® is a registered trademark of Carleton-Stuart Corp.



II 2 GD c TX

Warning: The TX marking refers to the maximum surface temperature depending not on the equipment itself, but mainly on operating conditions. In this case, the maximum surface temperature depends upon the temperature of the process fluids.

# WARRANTY AND REGISTRATION

**WARRANTY.** All All-Flo products shall be covered by the standard All-Flo Limited Warranty in effect at the time of shipment. This warranty (which may be modified by All-Flo at any time) provides:

MATERIALS SOLD ARE WARRANTED TO THE ORIGINAL USER AGAINST DEFECTS IN WORKMANSHIP OR MATERIALS UNDER NORMAL USE (RENTAL USE EXCLUDED) FOR FIVE YEARS AFTER PURCHASE DATE. ANY PUMP WHICH IS DETERMINED TO BE DEFECTIVE IN MATERIAL AND WORKMANSHIP AND RETURNED TO ALL-FLO, SHIPPING COSTS PREPAID, WILL BE REPAIRED OR REPLACED AT ALL-FLO'S OPTION. CUSTOMER SHALL NOTIFY ALL-FLO IN WRITING WITHIN 30 DAYS OF ANY CLAIMED DEFECTS. NO MATERIALS CAN BE RETURNED WITHOUT THE PRIOR CONSENT OF ALL-FLO, AND IF APPROVED SHALL BE RETURNED TO ALL-FLO FREIGHT PREPAID. ALL-FLO'S LIABILITY FOR ANY BREACH OF THIS WARRANTY SHALL BE LIMITED TO EITHER REPLACEMENT OF THE MATERIALS OR, AT ALL-FLO'S SOLE OPTION, THE REFUND OF THE PURCHASE PRICE. ALL-FLO SHALL NOT BE HELD LIABLE FOR ANY INCIDENTAL OR CONSEQUENTIAL DAMAGES CAUSED BY BREACH OF THIS WARRANTY. THIS EXCLUSION APPLIES WHETHER SUCH DAMAGES WERE SOUGHT BASED ON BREACH OF WARRANTY, BREACH OF CONTRACT, NEGLIGENCE, STRICT LIABILITY IN TORT, OR ANY OTHER LEGAL THEORY. FURTHER, ALL-FLO SHALL NOT BE LIABLE FOR LOSSES, DELAYS, LABOR COSTS, OR ANY OTHER COST OR EXPENSE DIRECTLY OR INDIRECTLY ARISING FROM THE USE OF MATERIALS. ALL-FLO'S LIABILITY IS EXPRESSLY LIMITED TO THE REPLACEMENT OR REPAIR OF DEFECTIVE GOODS, OR THE TOTAL VALUE OF SUCH GOODS. THIS WARRANTY IS IN LIEU OF ALL OTHER WARRANTIES, WHETHER EXPRESS, IMPLIED, OR ORAL INCLUDING THE IMPLIED WARRANTY OF MERCHANTABILITY, ANY IMPLIED WARRANTY OF FITNESS FOR A PARTICULAR PURPOSE, AND ANY IMPLIED WARRANTIES OTHERWISE ARISING FROM A COURSE OF DEALING OR TRADE. All-Flo will not, in ANY event, be liable for any loss of profit, interruption of business or any other special, consequential or incidental damages suffered or sustained by Customer. All-Flo's total maximum liability to the customer in respect of sale of materials or services rendered by All-Flo is limited to the total monies received by All-Flo from the customer for the particular materials described in Customer's order.

All-Flo does not warrant any part or component that it does not manufacture, but will assign to the original end-user purchaser of any warranty received by it from the manufacturer, to extent such pass through is permitted by the manufacturer.



## REGISTRATION FORM

Pump Model \_\_\_\_\_ Pump Serial Number \_\_\_\_\_

Company Name \_\_\_\_\_

Name \_\_\_\_\_ Email \_\_\_\_\_

Phone # \_\_\_\_\_ City \_\_\_\_\_ State \_\_\_\_\_ Zip \_\_\_\_\_

Qty of Pumps \_\_\_\_\_ Fluid Pumping \_\_\_\_\_

How did you hear about us? Existing All-Flo user,  
Web, Distributor, Magazine...

\_\_\_\_\_

**MAIL TO:** All-Flo | Attn: Product Registration

22069 Van Buren Street, Grand Terrace, CA 92313-5651



Scan QR code and  
complete form  
on mobile phone  
or visit

[www.all-flo.com/registration-form.html](http://www.all-flo.com/registration-form.html)



PSG

22069 Van Buren Street

Grand Terrace, CA 92313-5651 USA

P: +1 (440) 354-1700 F: +1 (440) 354-9466

[all-flo.com](http://all-flo.com)

All-Flo is committed to the pursuit of designing and manufacturing the highest quality product available to industry. Since the beginning in 1986, All-Flo engineers have used their extensive knowledge of today's engineered materials, advanced air system logic and manufacturing techniques to develop the superior group of lube-free, air-operated diaphragm pumps found in this catalog. Every pump is performance engineered and quality built to provide trouble-free service under the toughest conditions.



Where Innovation Flows