

IOM

INSTALLATION OPERATION
& MAINTENANCE

A300

METAL 3 INCH

AIR-OPERATED DOUBLE-DIAPHRAGM PUMP



TABLE OF CONTENTS

SECTION 1	WARNINGS, DANGERS AND CAUTIONS	3
SECTION 2	MODEL DESIGNATION MATRIX & REPAIR KITS	4-5
SECTION 3	PRINCIPLES OF OPERATION	6
SECTION 4	DIMENSIONAL DRAWINGS	7-8
SECTION 5	PERFORMANCE CURVES	
	RUBBER DIAPHRAGMS	9
	TPE DIAPHRAGMS	9
	PTFE DIAPHRAGMS.....	9
SECTION 6	INSTALLATION	
	INSTALLATION.....	10-11
	TROUBLESHOOTING.....	12
	OPERATION	13
	MAINTENANCE	13
SECTION 7	REPAIR AND ASSEMBLY	
	PUMP WET END REMOVAL.....	14-15
	AIR VALVE REMOVAL.....	16-17
	PILOT VALVE REMOVAL	18-19
	TORQUE SPECIFICATION CHART.....	19
SECTION 8	EXPLODED VIEWS & PARTS LIST	
	THREADED ALUMINUM.....	20-22
	FLANGED STAINLESS STEEL.....	23-25
SECTION 9	ELASTOMERS	26
SECTION 10	WARRANTY AND REGISTRATION	27

CAUTIONS — READ FIRST!

READ THESE WARNINGS AND SAFETY PRECAUTIONS PRIOR TO INSTALLATION OR OPERATION. FAILURE TO COMPLY WITH THESE INSTRUCTIONS COULD RESULT IN PERSONAL INJURY AND OR PROPERTY DAMAGE. RETAIN THESE INSTRUCTIONS FOR FUTURE REFERENCE.

WARNING Pump, valves and all containers must be properly grounded prior to handling flammable fluids and/or whenever static electricity is a hazard.

WARNING Prior to servicing the pump, ensure that the air and fluid lines are closed and disconnected. While wearing personal protective equipment, flush, drain and process liquid from the pump in a safe manner.

WARNING The TX marking refers to the maximum surface temperature depending not on the equipment itself, but mainly on operating conditions. In this case, the maximum surface temperature depends upon the temperature of the process fluids.

WARNING For pump models with non-metallic manifolds, air valves, or chambers: When the relative humidity in the surrounding atmosphere is above 30%, the equipment must not be touched by personnel unless first wiped down with a damp cloth.

WARNING Maintenance must not be performed when a hazardous atmosphere is present.

WARNING Use only with liquid process fluid.

WARNING This equipment's ambient temperature range is 32°F (0°C) to 104°F (40°C)

WARNING Do not operate the pump with fluids or in temperatures which are less than 32°F (0°C)

CAUTION The temperature of the process fluid and air input must be no more than 36°F (20°C) less of the maximum temperature allowed for the appropriate non-metallic material. See the list of temperatures below for each material's maximum recommended temperature:

Buna-N (Nitrile):	10°F to 180°F (-12°C to 82°C)
Geolast®:	10°F to 180°F (-12°C to 82°C)
EPDM:	-40°F to 280°F (-40°C to 138°C)
Santoprene®:	-40°F to 225°F (-40°C to 107°C)
FKM:	-40°F to 350°F (-40°C to 177°C)
PTFE:	40°F to 220°F (4°C to 104°C)
Polyethylene:	32°F to 158°F (0°C to 70°C)
Polypropylene:	32°F to 180°F (0°C to 82°C)
PVDF:	0°F to 250°F (-18°C to 121°C)
Nylon:	0°F to 200°F (-18°C to 93°C)

Temperature limits are solely based upon mechanical stress and certain chemicals will reduce the maximum operating temperature. The allowable temperature range for the process fluid is determined by the materials in contact with the fluid being pumped. Consult a chemical resistance guide for chemical compatibility and a more precise safe temperature limit. Always use minimum air pressure when pumping at elevated temperatures.

WARNING = Hazards or unsafe practices which could result in severe personal injury, death or substantial property damage

CAUTION = Hazards or unsafe practices which could result in minor personal injury, product or property damage.

CAUTION It is the end user's responsibility to maintain the process fluid's temperature during use.

CAUTION Do not connect a compressed air source to the exhaust port of the pump.

CAUTION Do not lubricate air supply.

CAUTION Do not exceed 120 psig (8.3 bar) air-inlet pressure.

CAUTION Do not exceed 10 psig (0.7 bar) or 23 ft-H₂O suction pressure.

CAUTION Ensure all wetted components are chemically compatible with the process fluid and the cleaning fluid.

CAUTION Ensure pump is thoroughly cleaned and flushed prior to installation into a process line.

CAUTION Always wear Personal Protective Equipment (PPE) when operating pump.

CAUTION Close and disconnect all compressed air and bleed all air from the pump prior to service. Remove all process fluid in a safe manner prior to service.

CAUTION Blow out all compressed air lines in order to remove any debris, prior to pump installation. Ensure that the muffler is properly installed prior to pump operation.

CAUTION Ensure air exhaust is piped to atmosphere prior to a submerged installation.

CAUTION Ensure all hardware is set to correct torque values prior to operation.

CAUTION The equipment must be inspected for visible damage prior to use.

WARNING This product can expose you to chemicals including Nickel, Chromium, Cadmium, or Cobalt, which are known to the State of California to cause cancer and/or birth defects or other reproductive harm. For more information, go to www.P65Warnings.ca.gov.

MODEL DESIGNATION MATRIX & REPAIR KITS - ALUMINUM

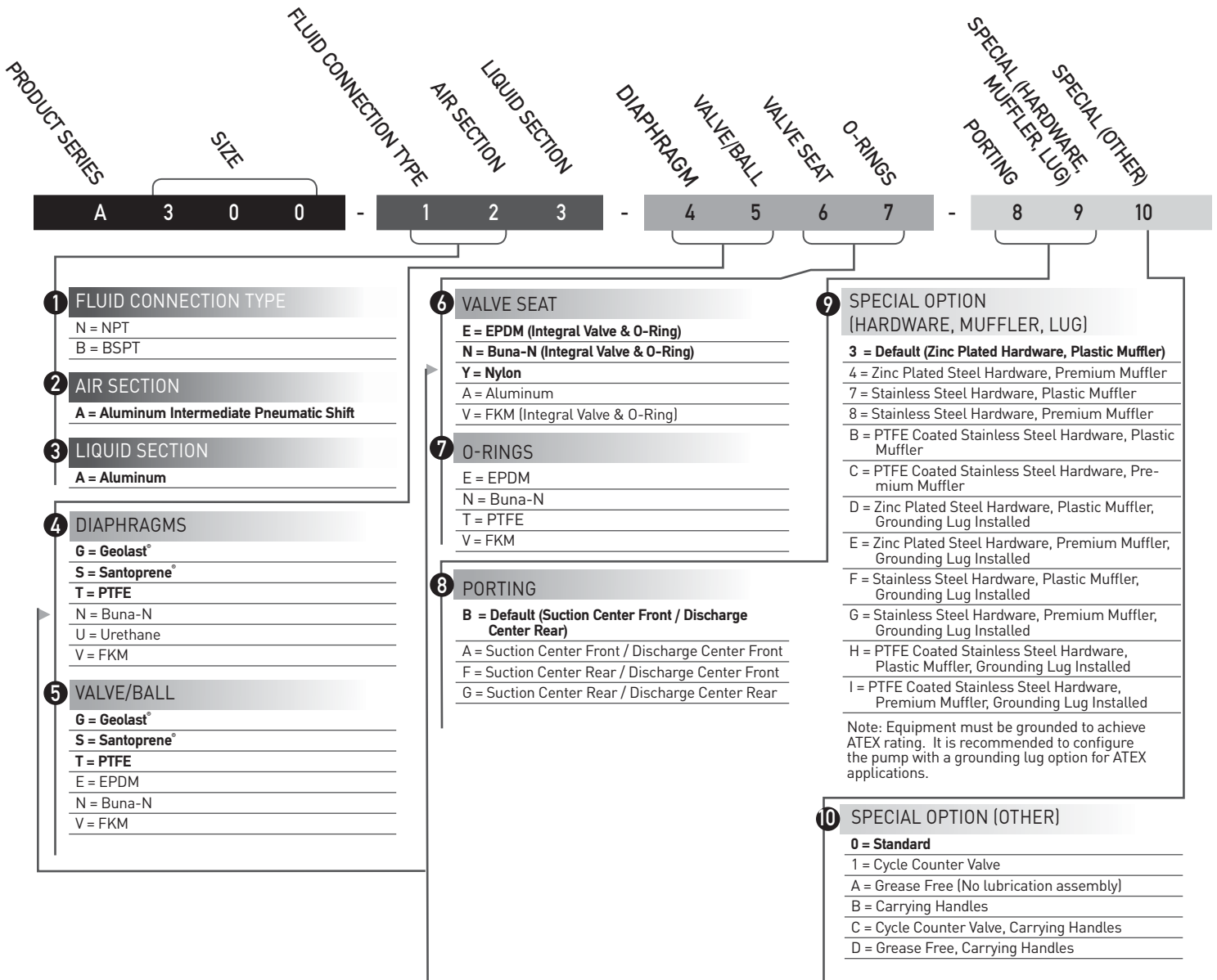

WET END REPAIR KIT

Wet end kits are available and consist of 2 diaphragms, (back-up diaphragms if required), 4 balls, 4 seats, and 4 seat O-rings (if required). See matrix below.

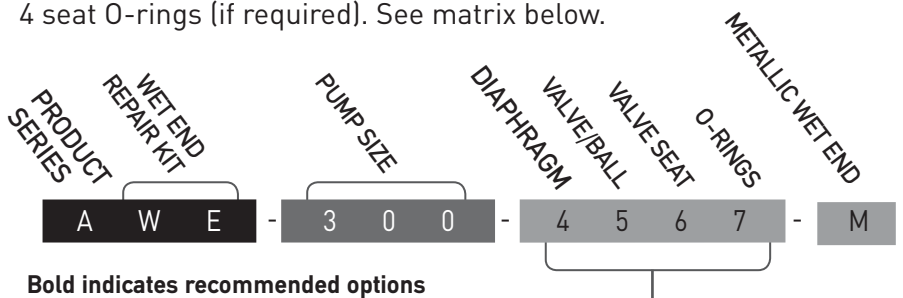

AIR END REPAIR KIT

Air end repair kit contains pilot sleeve assembly and main air valve.

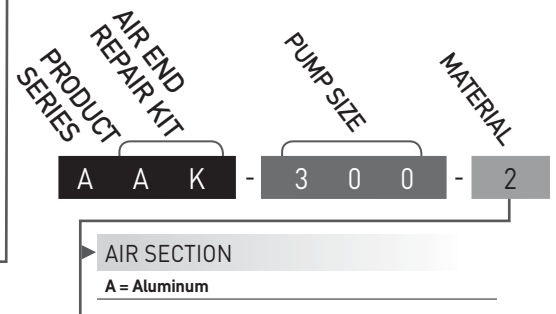

MODEL DESIGNATION MATRIX & REPAIR KITS - STAINLESS STEEL

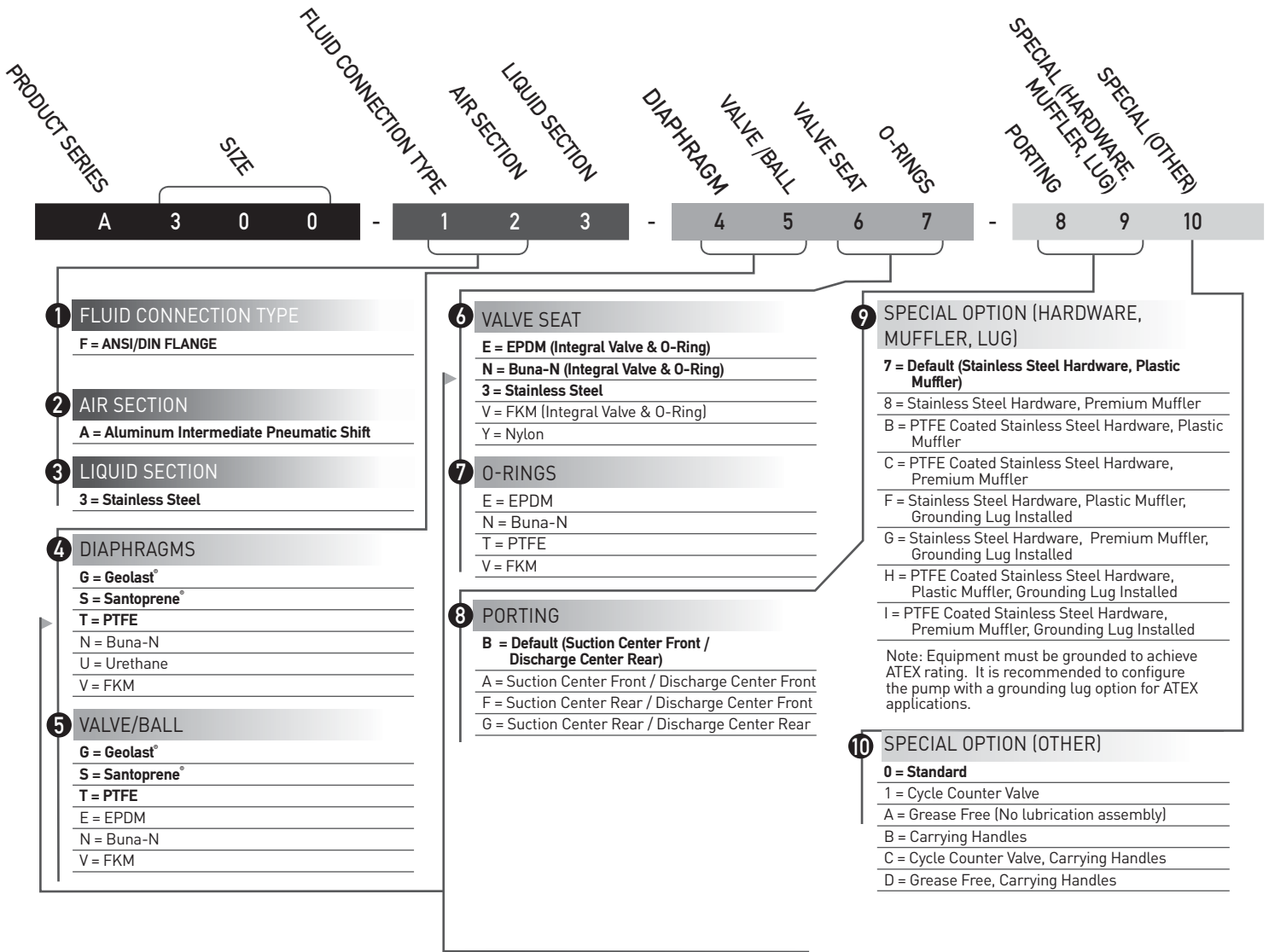

WET END REPAIR KIT

Wet end kits are available and consist of 2 diaphragms, (back-up diaphragms if required), 4 balls, 4 seats, and 4 seat O-rings (if required). See matrix below.

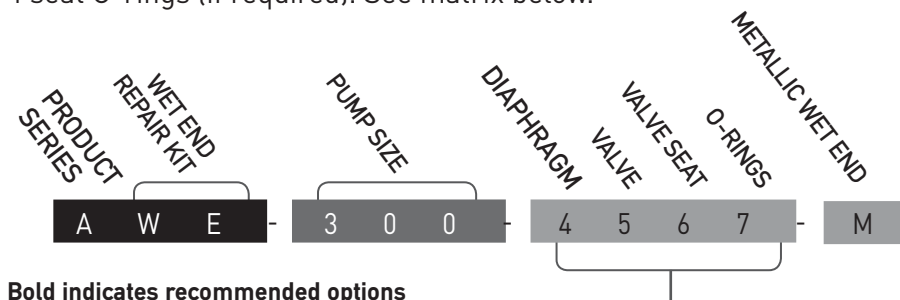

Bold indicates recommended options

AIR END REPAIR KIT

Air end repair kit contains pilot sleeve assembly and main air valve.

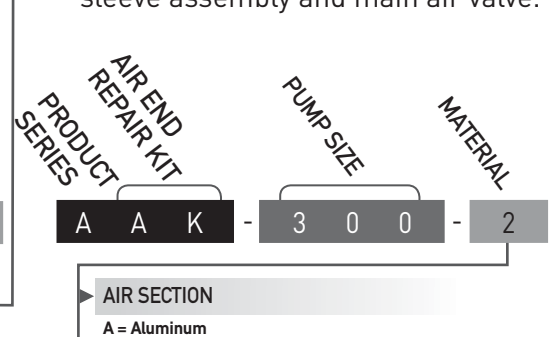

PRINCIPLES OF OPERATION

HOW AN AIR OPERATED DOUBLE DIAPHRAGM PUMP WORKS

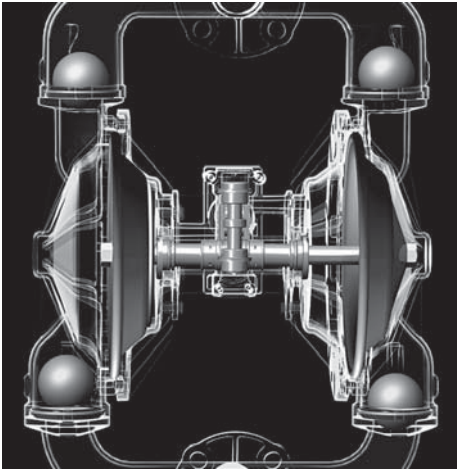

The air-valve directs pressurized air behind the diaphragm on the right, causing the diaphragm on the right to move outward (to the right).

Since both the right diaphragm and the left diaphragm are connected via a diaphragm rod, when the right diaphragm moves to the right, the left diaphragm (through the action of the diaphragm rod) moves to the right also.

When the diaphragm on the left side is moving to the right, it is referred to as suction stroke. When the left diaphragm is in its suction stroke, the left suction ball moves upward (opens) and the left discharge ball moves downward (closes). This action creates suction and draws liquid into the left side chamber.

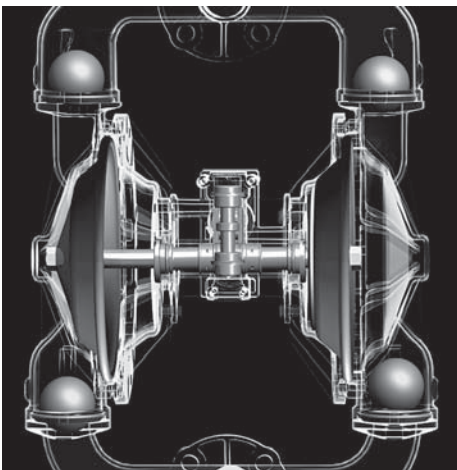

The air-valve directs pressurized air behind the left diaphragm, causing the left diaphragm to move outward (to the left).

Since both the left diaphragm and the right diaphragm are connected via a diaphragm rod, when the left diaphragm moves to the left, the right diaphragm (through the action of the diaphragm rod) moves to the left also.

When the diaphragm on the left side moves outward, the left discharge ball moves upward (opens) and the left suction ball moves downward (closes). This causes the liquid to leave the left side liquid outlet of the pump.

Simultaneously, the right diaphragm moves inward (to the left), which causes the right suction ball to open and the right discharge to close, which in turn causes suction, drawing liquid into the right chamber.

The process of alternating right suction / left discharge (and vice-versa) continues as long as compressed air is supplied to the pump.

3" PUMP DIMENSIONS

ALUMINUM - THREADED

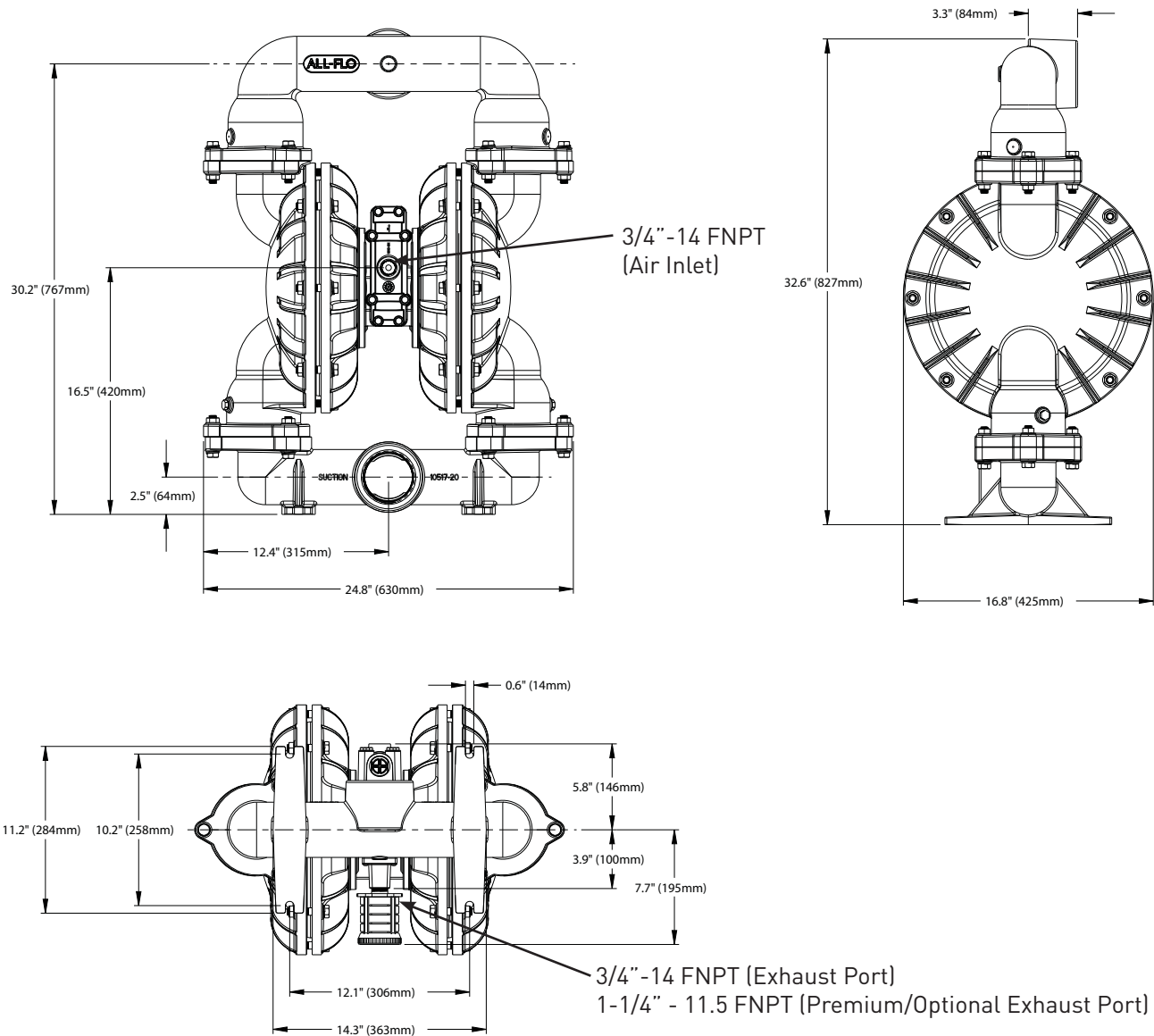

* Note - Suction Center Front / Discharge Center Rear are default ports. See part number matrix option code for additional porting options.

3" PUMP DIMENSIONS

STAINLESS STEEL - FLANGED

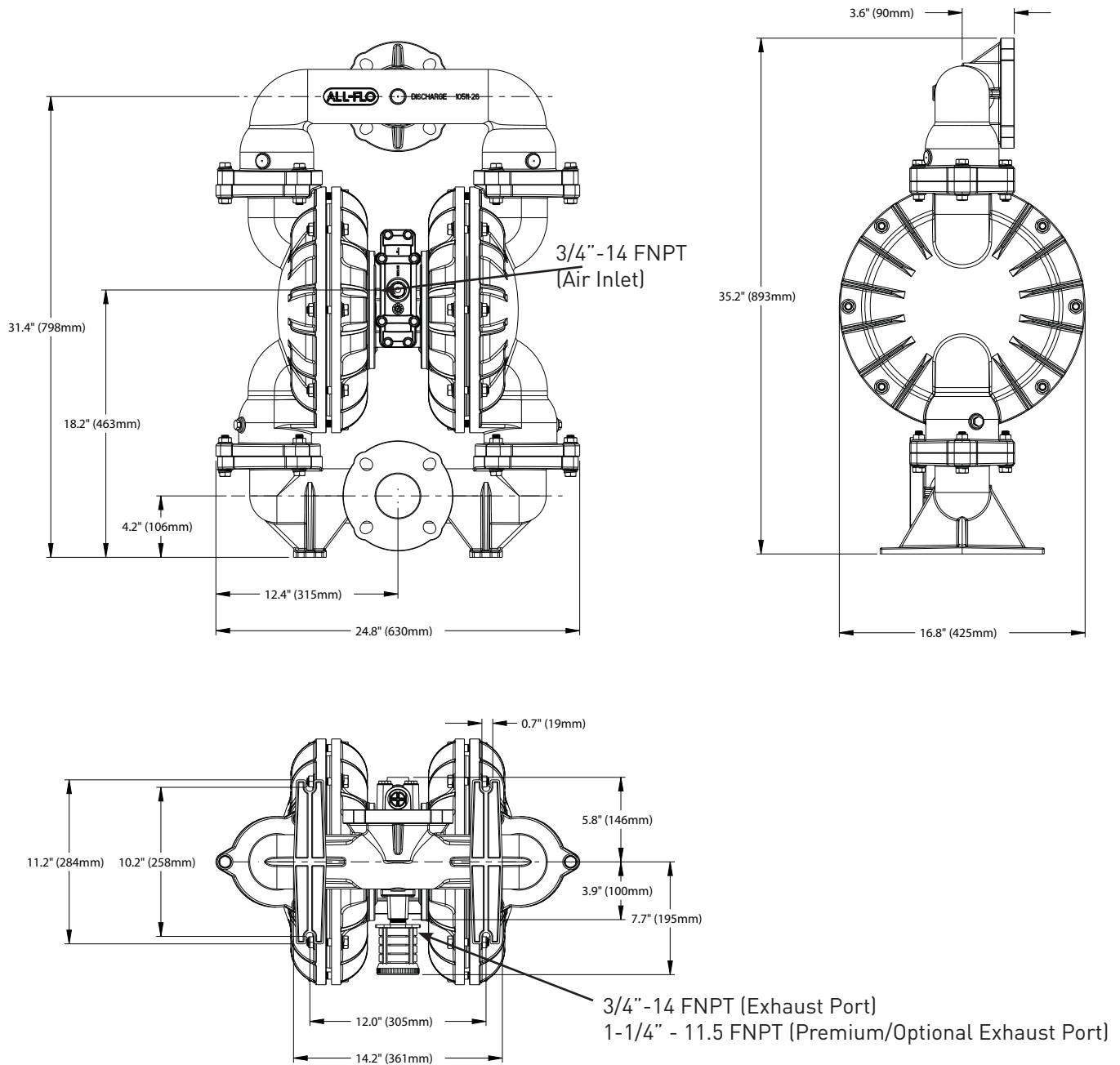

* Note - Suction Center Front / Discharge Center Rear are default ports. See part number matrix option code for additional porting options.

PERFORMANCE CURVES

PERFORMANCE CURVE (3" RUBBER)*

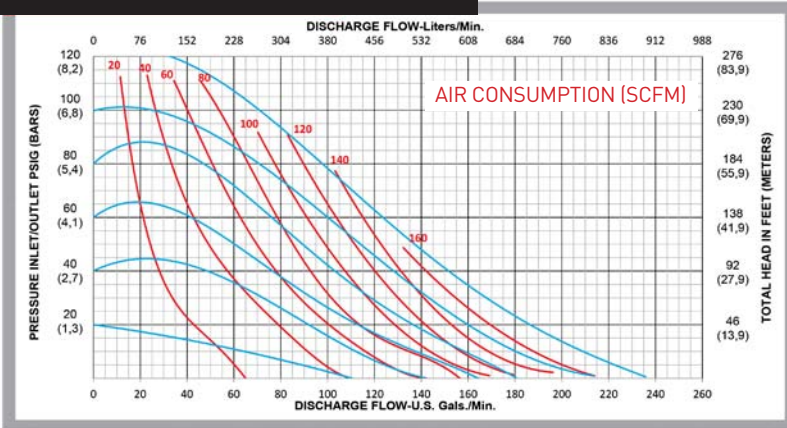

Performance Specifications

Max. Flow:	235 gpm (890 lpm)
Max. Air Pressure:	120 psi (8.3 bar)
Max. Solids:	7/16" (11 mm)
Max. Suction Lift Dry:	20 ft-H ₂ O (6.1 m-H ₂ O)
Max. Suction Lift Wet:	31 ft-H ₂ O (9.4 m-H ₂ O)
Weight:	AL-135 lbs (62 kg) / SS-300 lbs (136 kg)
Air Inlet:	3/4" FNPT
Liquid Inlet:	3" FNPT, 3" FBSPT, or ANSI/DIN Flanged
Liquid Outlet:	3" FNPT, 3" FBSPT, or ANSI/DIN Flanged
Height:	32.6" (827 mm) AL / 35.2" (893mm) SS
Width:	24.8" (630 mm)
Depth:	16.8" (425 mm)

PERFORMANCE CURVE (3" TPE)*

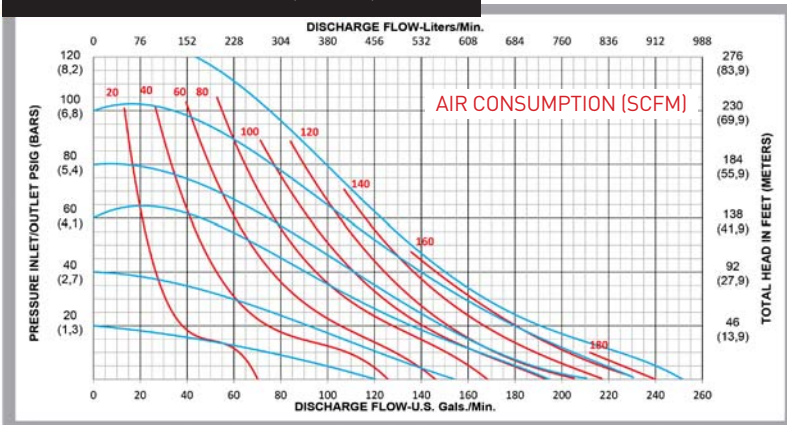

Performance Specifications

Max. Flow:	235 gpm (890 lpm)
Max. Air Pressure:	120 psi (8.3 bar)
Max. Solids:	7/16" (11 mm)
Max. Suction Lift Dry:	20 ft-H ₂ O (6.1 m-H ₂ O)
Max. Suction Lift Wet:	31 ft-H ₂ O (9.4 m-H ₂ O)
Weight:	AL-135 lbs (62 kg) / SS-300 lbs (136 kg)
Air Inlet:	3/4" FNPT
Liquid Inlet:	3" FNPT, 3" FBSPT, or ANSI/DIN Flanged
Liquid Outlet:	3" FNPT, 3" FBSPT, or ANSI/DIN Flanged
Height:	32.6" (827 mm) AL / 35.2" (893mm) SS
Width:	24.8" (630 mm)
Depth:	16.8" (425 mm)

PERFORMANCE CURVE (3" PTFE)*

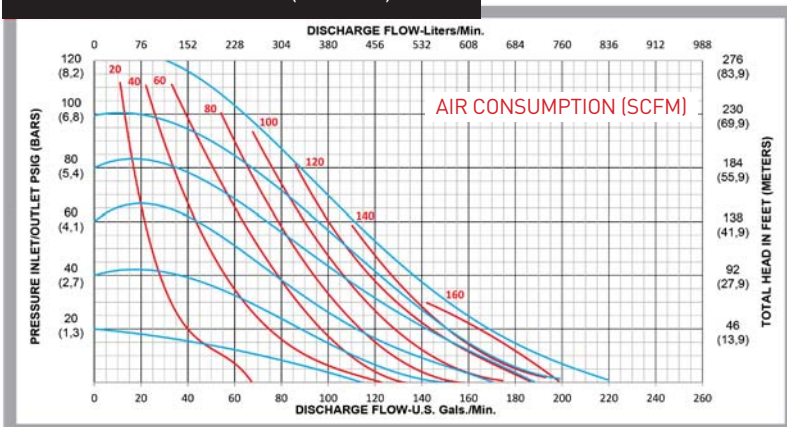

Performance Specifications

Max. Flow:	235 gpm (890 lpm)
Max. Air Pressure:	120 psi (8.3 bar)
Max. Solids:	7/16" (11 mm)
Max. Suction Lift Dry:	17 ft-H ₂ O (5.2 m-H ₂ O)
Max. Suction Lift Wet:	31 ft-H ₂ O (9.4 m-H ₂ O)
Weight:	AL-135 lbs (62 kg) / SS-300 lbs (136 kg)
Air Inlet:	3/4" FNPT
Liquid Inlet:	3" FNPT, 3" FBSPT, or ANSI/DIN Flanged
Liquid Outlet:	3" FNPT, 3" FBSPT, or ANSI/DIN Flanged
Height:	32.6" (827 mm) AL / 35.2" (893mm) SS
Width:	24.8" (630 mm)
Depth:	16.8" (425 mm)

*Flow rates indicated on all three charts shown were determined by pumping water at flooded suction.

For optimum life and performance, pumps should be specified so that daily operation parameters will fall in the center of the pump performance curve.

INSTALLATION, TROUBLESHOOTING AND MAINTENANCE

INSTALLATION PIPING

Whenever possible ensure the pump is installed using the shortest possible pipe lengths with the minimum amount of pipe fittings. Ensure all piping is supported independent of the pump.

Suction and discharge piping should not be smaller than the connection size of the pump. When pumping liquids of high viscosity, larger piping may be used, in order to reduce frictional pipe loss.

Employ flexible hoses in order to eliminate the vibration caused by the pump. Mounting feet can also be used to reduce vibration effects.

All hoses should be reinforced, non-collapsible and be capable of high vacuum service. Ensure that all piping and hoses are chemically compatible with the process and cleaning fluid.

For processes where pulsation effects should be reduced, employ a pulsation dampener on the discharge side of the pump.

For self-priming applications, ensure all connections are airtight and the application is within the pumps dry-lift capability. Refer to product specifications for further details.

For flooded suction applications, install a gate valve on the suction piping in order to facilitate service.

For unattended flooded suction operation, it is recommended to pipe the exhaust air above the liquid source. In the event of a diaphragm failure this will reduce or eliminate the possibility of liquid discharging through the exhaust onto the ground.

LOCATION

Ensure that the pump is installed in an accessible location, in order to facilitate future service and maintenance.

AIR

Ensure that the air supply is sufficient for the volume of air required by the pump. Refer to product specifications for further details. For reliable operation, install a 5 micron air filter, air-valve and pressure regulator. Do not exceed the pumps maximum operating pressure of 120 psig.

REMOTE OPERATION

Utilize a three way solenoid valve for remote operation. This ensures that air between the solenoid and the pump is allowed to “bleed off,” ensuring reliable operation. Liquid transfer volume is estimated by multiplying displacement per stroke times the number of strokes per minute

NOISE

Correct installation of the muffler reduces sound levels. Refer to product specifications for further details.

SUBMERGED OPERATION

For submersible operation, pipe the air exhaust to atmosphere

GROUNDING THE PUMP

Loosen grounding screw and install a grounding wire. Tighten grounding screw. Wire size should be a 12 gauge wire or larger. Connect the other end of the wire to a true earth ground. Equipment must be grounded to achieve ATEX rating and it is recommended to configure the pump with a grounding lug option.



SUGGESTED INSTALLATION

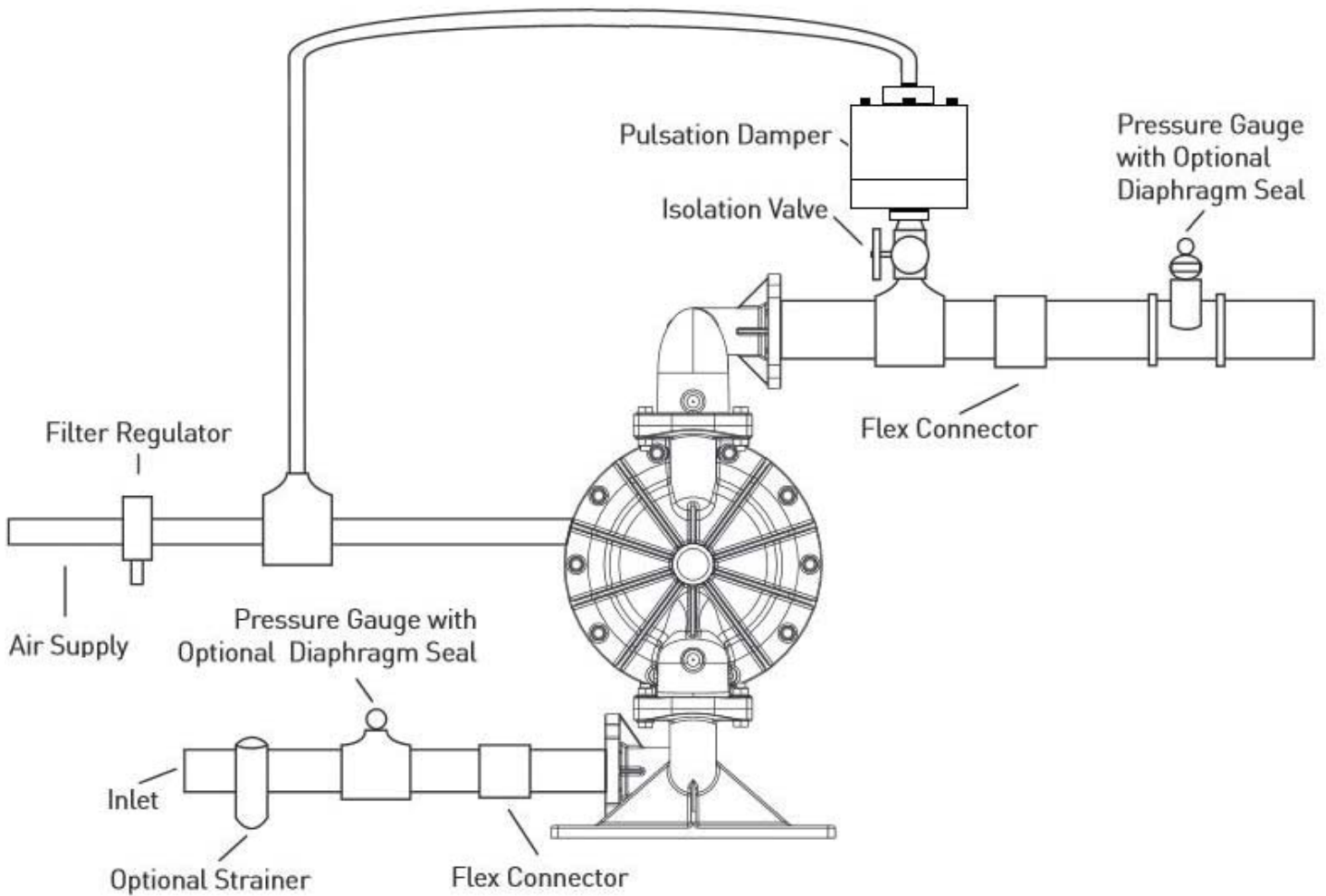

This illustration is a generic representation of an air operated double-diaphragm pump.

TROUBLESHOOTING

PROBLEM

EFFECT/SOLUTION

Pump Will Not Cycle

Discharge line closed or plugged
 Discharge filter blocked
 Check valve stuck
 Air filter blocked
 Air supply valve closed
 Air supply hooked up to muffler side of pump
 Compressor not producing air or turned off
 Muffler iced or blinded
 Diaphragm ruptured
 Plant air supply line ruptured
 Air valve wear/debris
 Pilot sleeve wear/debris
 Diaphragm rod broken
 Diaphragm plate loose

Pumped Fluid Coming Out of Muffler

Diaphragm ruptured
 Diaphragm plate loose
 Inlet liquid pressure excessive (above 10 psig)

Pump Cycles but no Flow

Inlet strainer clogged
 Suction valve closed
 Suction line plugged
 No liquid in the suction tank
 Suction lift excessive
 Debris stuck in valves
 Excessive wear of check valves
 Air leak on suction side with suction lift

Pump Cycles with Closed Discharge Valve

Debris stuck in check valve
 Excessive wear of check valves

Pump Running Slowly/Not Steady

Air compressor undersized
 Leak in air supply
 Air-line, filter regulator or needle valve undersized
 Muffler partially iced or blinded
 Air valve gasket leak or misalignment
 Air valve wear/debris
 Pilot sleeve wear/debris
 Liquid fluid filter blocked
 Pump may be cavitating, reduce speed of operation
 Suction strainer clogged

Pump Will Not Prime

Air leak in suction pipe
 Air leak in pump manifold connections
 Suction strainer and lines clogged
 Excessive lift conditions
 Check valve wear
 Debris in check valve

OPERATION

The Air-Operated Double Diaphragm Pump requires a minimum of 20 psig of air to operate, with some variation according to diaphragm material. Increasing the air pressure results in a more rapid cycling of the pump and thus a higher liquid flow rate. In order to not exceed 120 psig of inlet air pressure, and for accurate control of the pump, it is suggested to use a pressure regulator on the air inlet.

An alternate means of controlling the flow-rate of the pump is to use an inlet air valve and partially open or close accordingly. When the air valve is completely in the closed position, the pump will cease to operate.

A third method of controlling the flow rate of the pump is to use a liquid discharge valve. Closing the liquid discharge valve will cause a decrease in the flow rate since the pump will operate against a higher discharge pressure.

Solenoid control of the inlet air may also be used in order to facilitate remote operation. A three way solenoid valve is recommended, in order to allow the air to “bleed off” between the solenoid and the pump.

Do not use valves for flow control on the suction side of the pump. (Closing or partially closing a liquid suction valve restrict the suction line and may cause damage to the diaphragms.) Suction strainers may be employed to reduce or eliminate larger solids, but routine maintenance is necessary in order to prevent a restriction on the suction.

MAINTENANCE

Due to the unique nature of each application, periodic inspection of the pump is the best method to determine a proper maintenance schedule. A record should be kept of all repairs made to an installed pump. This will serve as the best predictor of future maintenance.

Typical maintenance involves replacing of “wear-parts” such as the diaphragms, balls, valve seats and O-rings. Proper maintenance can ensure trouble-free operation of the pump. Refer to repair and assembly instructions for further details.

 **WARNING** Maintenance must not be performed when a hazardous atmosphere is present.

MAINTENANCE SCHEDULE

WEEKLY (OR DAILY)

Make a visual check of the pump. If pumped fluid is leaking out of the pump, pipe fittings or muffler turn off pump and schedule maintenance.

EVERY THREE MONTHS

Inspect fasteners and tighten any loose fasteners to recommended torque settings.

Schedule pump service based on pump’s service history.

REPAIR AND ASSEMBLY

PUMP WET END REMOVAL

TOOLS NEEDED

- 1) Two Wrenches, 3/4 Inch
- 2) Two Adjustable Wrenches or Vice
- 3) One Socket Wrench, 9/16 Inch
- 4) One Socket Wrench, 1-1/16 Inch
- 5) One Spanner Wrench, 3/4 Inch
(May Be Required) - A vice may be required

⚠ WARNING Prior to servicing the pump, ensure that the air and fluid lines are closed and disconnected. While wearing personal protective equipment, flush, drain and process liquid from the pump in a safe manner.

⚠ WARNING Maintenance must not be performed when a hazardous atmosphere is present.



STEP 1

Using the 3/4 inch wrench remove six "Hex-Head Cap Screws (1/2" - 13x2-1/2")", six "Flat & Lock Washers (1/2")" and six "Flanged Hex Nuts (1/2" - 13)" from the "Discharge Manifold".



STEP 2

Remove the "Discharge Manifold".



STEP 3

Remove the "O-Ring", "Valve Seat" and "Ball".

Note: some models have an integral rubber seat and seal.



STEP 4

Using the 3/4 inch wrench remove six "Hex-Head Cap Screws (1/2" - 13x2-1/2")", six "Flat & Lock Washers (1/2")" and six "Flanged Hex Nuts (1/2" - 13)" from the "Suction Manifold".



STEP 5

Remove the "Suction Manifold".



STEP 6

Remove the "O-Ring", "Valve Seat" and "Ball".

Note: some models have an integral rubber seat and seal.

**STEP 7**

In order to remove both "Outer Chambers" use two $\frac{3}{4}$ Inch wrenches. Remove eight "Hex-Head Cap Screws ($\frac{1}{2}$ "-13)", eight "Flat Washers ($\frac{1}{2}$ ")" and eight "Flanged Hex Nuts ($\frac{1}{2}$ "-13)" from each "Outer Chamber".

**STEP 8**

Remove both "Outer Chambers" from the "Intermediate."

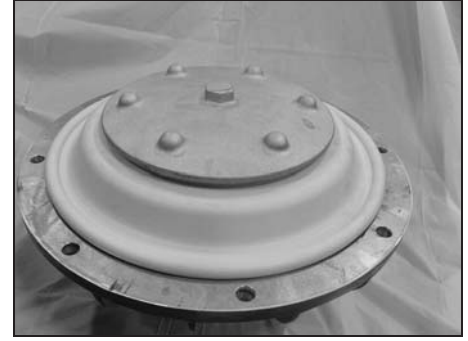
**STEP 9**

Using two adjustable wrenches (or a wrench $1\text{-}\frac{5}{32}$ " and a vice), remove "Outer Diaphragm Plate", "Diaphragm" & "Inner Diaphragm Plate" from one side of the pump.

**STEP 10**

Remove the "Bumper" and large "Washer" ($2\text{-}\frac{3}{8}$ ") from the threaded rod stud (Aluminum models only).

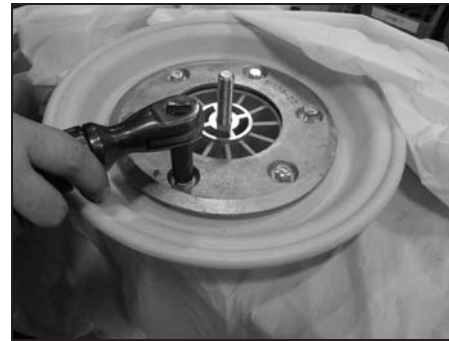
**STEP 11**

Using the $\frac{9}{16}$ inch socket wrench, remove six "Hex-Head Cap Screws ($\frac{3}{8}$ "-16x1- $\frac{1}{4}$ ")" and six "Washers" ($\frac{3}{8}$ "). Remove "Inner Diaphragm Plate" and "Outer Diaphragm Plate" from "Diaphragm."

PUMP WET END ASSEMBLY

To assemble the wet end of the pump, reverse the order of disassembly. Ensure all hardware is fastened in accordance with torque specifications [see page 19]. Inverting one of the diaphragms during reassembly will facilitate ease of assembly.

Note: On pumps built before 2018, shorter bolts ($1\text{-}\frac{1}{2}$ ") may have been used at the 6 and 12 O'Clock position of the chamber bolt patterns and thread directly into blind tapped holes (no nuts).

REPAIR AND ASSEMBLY

AIR VALVE REMOVAL

TOOLS NEEDED

- 1) One Wrench, 7/16 Inch
- 2) One Pick, General Purpose
- 3) One Pair of Pliers

⚠ WARNING Prior to servicing the pump, ensure that the air and fluid lines are closed and disconnected. While wearing personal protective equipment, flush, drain and process liquid from the pump in a safe manner.

⚠ WARNING Maintenance must not be performed when a hazardous atmosphere is present.

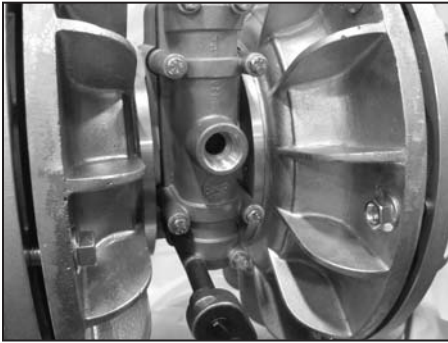

STEP 1

Using the 7/16 inch wrench, remove eight "Hex Head Cap Screws (1/4"-20 x 3")", eight "Lock Washers (1/4)" and eight "Flat Washers (1/4)".



STEP 2

Remove the main "Air-Valve Assembly" from the pump.



STEP 3

Remove the "Air-Valve Gasket" from the main "Air-Valve Assembly".



STEP 4

Remove the "Shuttle Plate" from the main "Air-Valve Assembly".

Note: The smooth shiny side of the shuttle plate should be toward the shuttle car.

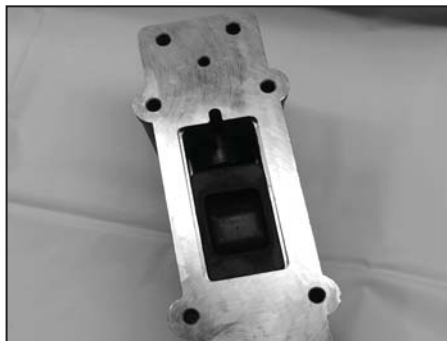

STEP 5

Remove the "Shuttle" from the main "Air-Valve Assembly".

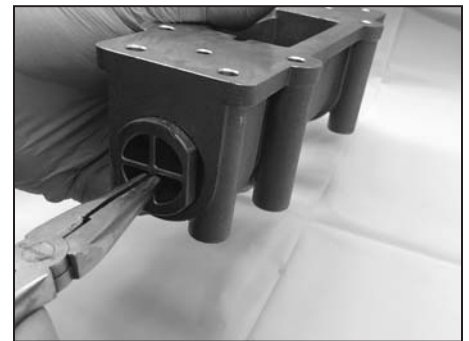

STEP 6

Using the pair of pliers, remove the "Air Valve End Plug" from the main "Air-Valve Assembly".

Ensure the "O-Ring" is installed when reassembling.

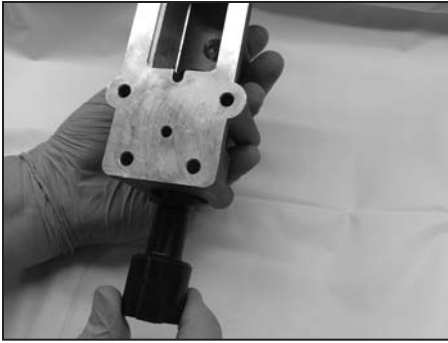

STEP 7

Remove the "Air Valve Spool" from the main "Air-Valve Assembly".



STEP 8

Using the pick, remove the "Lip Seal (Air Valve)" from the main "Air-Valve Assembly".

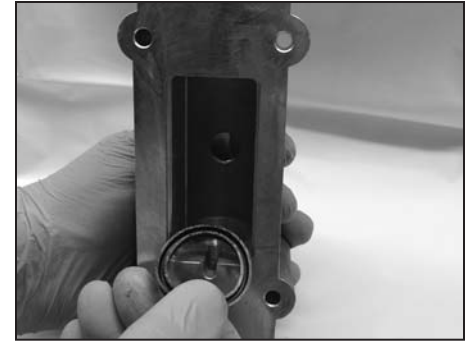

STEP 9

Using the pick, remove the second "Lip Seal (Air Valve)" from the main "Air-Valve Assembly".



STEP 10A

Air Valve Orientation

The longer piston with the leading chamfer is to be on the top facing up. Arrow points up on the main air valve casting.

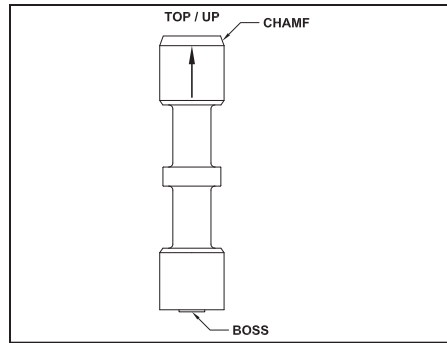

STEP 10B

Spool Orientation

AIR VALVE ASSEMBLY

To assemble the air valve, reverse the order of disassembly. During assembly, ensure that the open side of the lip-seals are both facing each other inward. Install the shuttle plate with the smooth/shiny side toward the shuttle car. Lubrication of the air valve assembly, with a non-synthetic lubricant, is recommended. Magna-Lube or Magna-Plate are recommended for assembly lubrication (see detailed parts list for ordering information).

Note that if the lip-seals are installed incorrectly, they will be unable to rotate. Insert the spool, the spool's longer piston with leading chamfer is to be on the top side of the air valve casting, ensure O-Rings are installed, and then the air-valve end plugs into position.

REPAIR AND ASSEMBLY

PILOT VALVE REMOVAL

TOOLS NEEDED

- 1) One Screwdriver, Phillips #2
- 2) Two Wrenches, 3/4 Inch

The chambers do not need to be removed for this procedure. The graphics show the inner chambers removed for clarity.

⚠ WARNING Prior to servicing the pump, ensure that the air and fluid lines are closed and disconnected. While wearing personal protective equipment, flush, drain and process liquid from the pump in a safe manner.

⚠ WARNING Maintenance must not be performed when a hazardous atmosphere is present.



STEP 1

Using the screwdriver, remove three “Phillips Flat Head Mach Screw (#6-32-x 3/4”)” in order to remove the “Retaining Plate”. Repeat for both sides of the pump.



STEP 2

Remove the “Diaphragm Rod” and the “Pilot Sleeve Assembly” from the “Intermediate”.

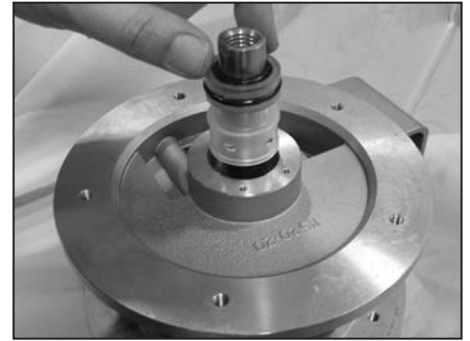

STEP 3

Remove the “Lip Seal” and “End Spacer”.



STEP 4

Remove “O-rings” and “Inner Spacer”.

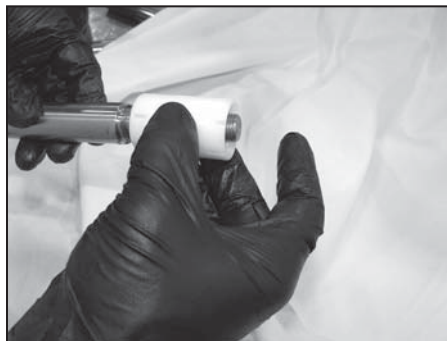

STEP 5

Remove “Pilot Sleeve” from diaphragm rod. The two piece rod must be disassembled to remove the “Pilot Sleeve”. Use the 3/4 inch wrenches to separate the rod. Note they are installed with threadlocker.

PILOT VALVE ASSEMBLY

To assemble the pilot valve, reverse the order of disassembly. Thread locking sealant should be applied to the inner diaphragm rod threads (red) and the retainer plate screws (blue) when installed. Should process fluid have contact with the pilot valve o-rings, they should be replaced as swelling may occur and cause irregular operation. During assembly, ensure that the open side of the lip-seals are facing outward. Lubrication of the pilot sleeve assembly, with a non-synthetic lubricant, is recommended in order to facilitate re-assembly into the intermediate. Magna-Lube or Magna-Plate are recommended for assembly lubrication (see detailed parts list for ordering information).

TORQUE SPECIFICATION CHART

RECOMMENDED TORQUE SPECIFICATIONS

	3" Pumps	Wrench Size
Manifold Bolts	50 ft-lbs (67.8 N-m)	3/4"
Chamber Bolts	30 ft-lbs (40.7 N-m)	3/4"
Air Valve Bolts	40 in-lbs (4.5 N-m)	7/16"
Inner/Outer Diaphragm Plate Bolts	12.5 ft-lbs (16.9 N-m)	9/16"
Chamber/Intermediate Bolts	100 in-lbs (11.3 N-m)	1/2"
Diaphragm Rod	Tighten until mechanical interference (hard stop) then 1/8 to 1/4 turn more	

EXPLODED VIEW & PARTS LIST

ALUMINUM, A300-*AA-****-***

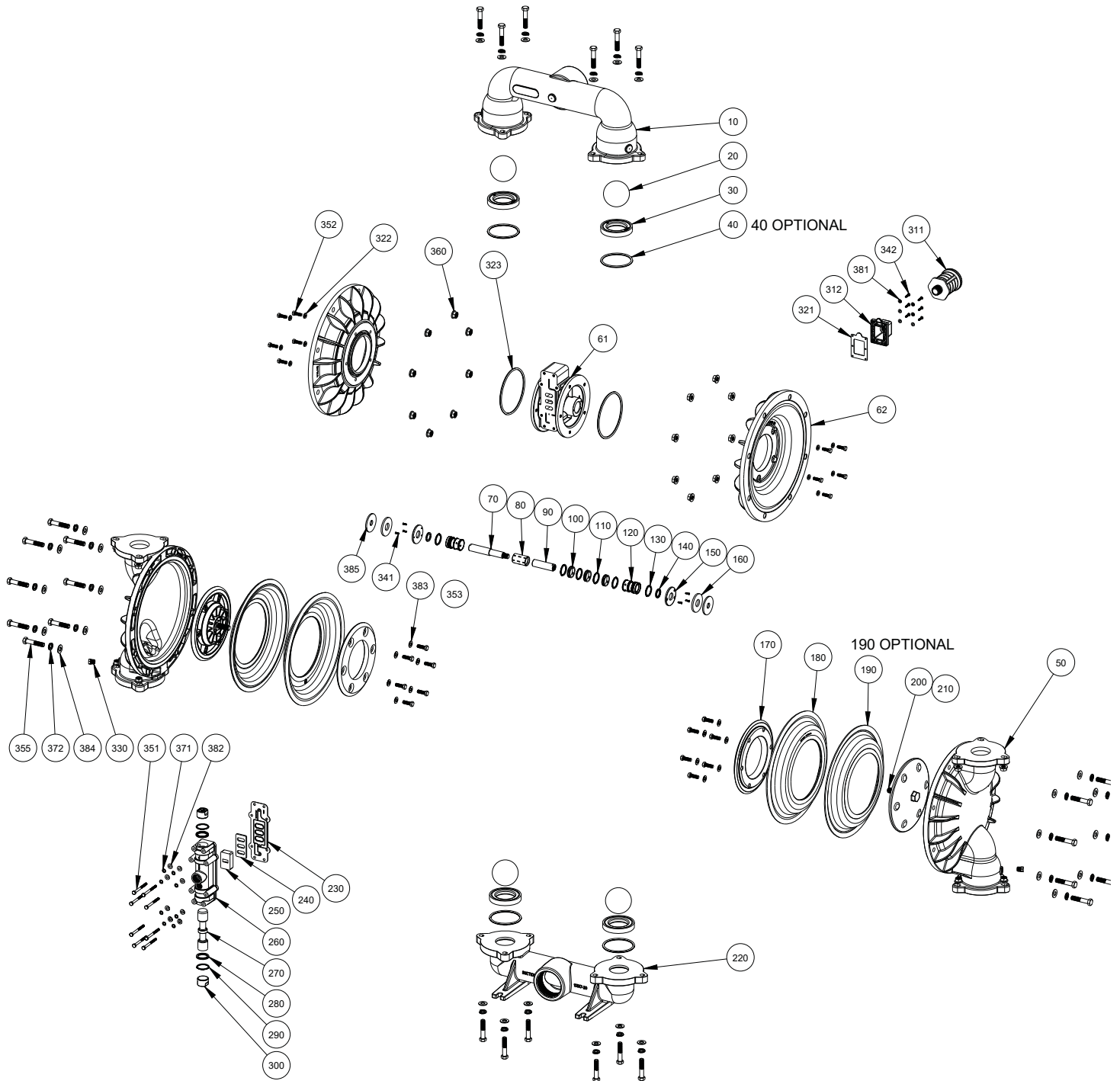

PARTS LIST - ALUMINUM, A300-*AA-****-***

NO.	DESCRIPTION	QTY	PUMP MODEL	PART NO.	MATERIAL
10	DISCHARGE MANIFOLD	1	A300-NAA-****-*** A300-BAA-****-***	10519-20-NPT 10519-20-BSPT	Aluminum Aluminum
20	BALL	4	A300-*A*-*V**-* A300-*A*-*E**-* A300-*A*-*G**-* A300-*A*-*N**-* A300-*A*-*S**-* A300-*A*-*T**-*	11007-13 11007-15 11007-19 11007-21 11007-23 11007-45	FKM EPDM Geolast® Buna-N Santoprene® PTFE
30	VALVE SEAT (VALVE SEATS 10905-13, -15 & -19 HAVE INTEGRAL VALVE & O-RING)	4	A300-*A*-*V*-*** A300-*A*-*EE*-*** A300-*A*-*NN*-*** A300-*A*-*A*-*** A300-*A*-*3*-*** A300-*A*-*Y*-***	10905-13 10905-15 10905-19 10905-20 10905-26 10905-42	FKM EPDM Buna-N Aluminum Stainless Steel Nylon
40	O-RING (VALVE SEAT) (OPTIONAL- ONLY USED WITH A300-*A*-*A*-* A300-*A*-*3*-*** & A300-*A*-*Y*-***)	4	A300-*A*-*N*-*** A300-*A*-*V*-*** A300-*A*-*E*-*** A300-*A*-*T*-***	11934-11 11934-13 11934-15 11934-17	Nitrile FKM EPDM PTFE
50	OUTER CHAMBER	2	A300-*AA-****-***	10704-A300-20	Aluminum
61	INTERMEDIATE	1	All Models	11520-A300-20	Aluminum
62	INNER CHAMBER	2	All Models	11802-A300-20	Aluminum
70 & 90	DIAPHRAGM ROD ASSEMBLY	1	A300-*AA-****-***	35006-00	Stainless Steel
80	PILOT SLEEVE	1	All Models	10106-31 Δ	Acetal
100	INNER SPACER, PILOT SLEEVE	3	All Models	10205-40 Δ	Polypropylene
110	O-RING (PILOT SLEEVE SPACER)	4	All Models	11919-16 Δ	Urethane
120	END SPACER, PILOT SLEEVE	2	All Models	10206-40 Δ	Polypropylene
130	O-RING (END SPACER)	2	All Models	11919-11 Δ	Nitrile
140	LIP SEAL (AIR VALVE)	2	All Models	12002-76 Δ	Nitrile
150	RETAINING PLATE	2	All Models	12712-A300-20	Aluminum
160	BUMPER	2	All Models	12309-16	Urethane
170	INNER DIAPHRAGM PLATE	2	All Models	11107-20	Aluminum
180	DIAPHRAGM (BACKUP)	2	A300-*A*-*N***-* A300-*A*-*V***-* A300-*A*-*E***-* A300-*A*-*G***-* A300-*A*-*S***-* A300-*A*-*T***-*(PTFE)	10608-11 10608-13 10608-16 10608-19 10608-23 10608-23	Buna-N FKM Urethane Geolast® Santoprene® Santoprene®
190	OVERLAY (PTFE ONLY)	2	A300-*A*-*T***-*	11407-59	PTFE
200 & 210	OUTER DIAPHRAGM PLATE W/ THREADED STUD	2	A300-*AA-****-***	11222-20	Aluminum
220	SUCTION MANIFOLD	1	A300-NAA-****-*** A300-BAA-****-***	10517-20-NPT 10517-20-BSPT	Aluminum Aluminum
230	GASKET, AIR VALVE	1	All Models	12115-19 ‡	Nitrile
240	SHUTTLE PLATE	1	All Models	10414-26 ‡	Stainless Steel
250	SHUTTLE	1	All Models	10413-32 ‡	Special
260	AIR VALVE BODY	1	All Models	11613-20 ‡	Aluminum
270	AIR VALVE SPOOL	1	All Models	10412-31 ‡	Acetal

PARTS LIST - ALUMINUM, A300-*AA-****-***

ITEM	DESCRIPTION	QTY	PUMP MODEL	PART NO.	MATERIAL
280	LIP SEAL (DIAPHRAGM ROD)	2	All Models	12003-76 ‡	Nitrile
290	O-RING (AIR VALVE END PLUG)	2	All Models	11913-11 ‡	Nitrile
300	AIR VALVE END PLUG	2	All Models	11706-20 ‡	Aluminum
311	MUFFLER	1	All Models	13001-00	Polypropylene
	OPTIONAL - PREMIUM METAL		Optional	13009-00	Aluminum
			A300-*A*-****-*Z*; Z=4, 8, C, E, G, I	13010-00	Aluminum
312	MUFFLER PLATE	1	All Models	13107-60	Polypropylene
	OPTIONAL - PREMIUM METAL		Optional	13107-20-125	Aluminum
			A300-*A*-****-*Z*; Z=4, 8, C, E, G, I		
321	MUFFLER GASKET	1	All Models	12108-11	Nitrile
322	WASHER, SEALING	10	All Models	12352-26	Stainless Steel
323	O-RING (CHAMBER/INTERMEDIATE)	2	All Models	11956-11	Nitrile
330	PIPE PLUG	2	A300-*AA-****-***	12205-42	Nylon
341	SCREW, PHILLIPS FLAT HEAD (#6-32 X 1/2")	6	All Models	12550-050-MS-26	Stainless Steel
342	SCREW, PHILLIPS PAN (#8-32 X 3/4" (1-1/8"))	6	All Models	12531-075-MS-26	Stainless Steel
	Optional - Premium Metal		Optional	12531-113-26	Stainless Steel
			A300-*A*-****-*Z*; Z=4, 8, C, E, G, I		
351	CAP SCREW (1/4"-20 X 3")	8	A300-*AA-****-***	12516-25	Plated Steel
			Optional	12516-26	Stainless Steel
352	CAP SCREW, HEX HEAD (5/16"-18 X 1")	10	All Models	12537-26	Stainless Steel
353	CAP SCREW (3/8"-16 X 1-1/4")	12	All Models	12534-25	Plated Steel
355	CAP SCREW (1/2"-13 X 2-1/2")	28	A300-*AA-****-***	12522-25	Plated Steel
			Optional	12522-26	Stainless Steel
360	NUT, FLANGE (1/2"-13)	28	A300-*AA-****-***	12582-25	Plated Steel
			Optional	12582-26	Stainless Steel
371	WASHER, LOCK (1/4")	8	A300-*AA-****-***	12350-25	Plated Steel
			Optional	12350-26	Stainless Steel
372	WASHER, SPLIT LOCK (1/2")	28	A300-*AA-****-***	12323-25	Plated Steel
			Optional	12323-26	Stainless Steel
381	WASHER (5/32")	6	All Models	12311-26	Stainless Steel
382	WASHER (1/4")	8	A300-*AA-****-***	12300-25	Plated Steel
			Optional	12300-26	Stainless Steel
383	WASHER (3/8")	12	All Models	12303-25	Plated Steel
384	WASHER (1/2")	28	A300-*AA-****-***	12306-25	Plated Steel
			Optional	12306-26	Stainless Steel
385	WASHER, CUSTOM	2	All Models	12312-25	Plated Steel
390	N/A				
400	GROUNDING LUG (NOT SHOWN)	1	All Models	13480-20	Aluminum
	Magnalube .75 OZ.		As Required, All Models	13404-00	Grease

* Any Character

‡ , Δ Only sold as part of assembly

ASSEMBLY PART NUMBERS	PUMP MODEL	PART NO.	MATERIAL
‡ PILOT VALVE ASSEMBLY	A300-*AA-****-***	APK-300-A	Various
80, 100, 110, 120, 130, 140			
Δ MAIN AIR VALVE ASSEMBLY	A300-*AA-****-***	AMK-300-A	Various
230, 240, 250, 260, 270, 280, 290, 300			

STAINLESS STEEL, A300-FA3-****-***

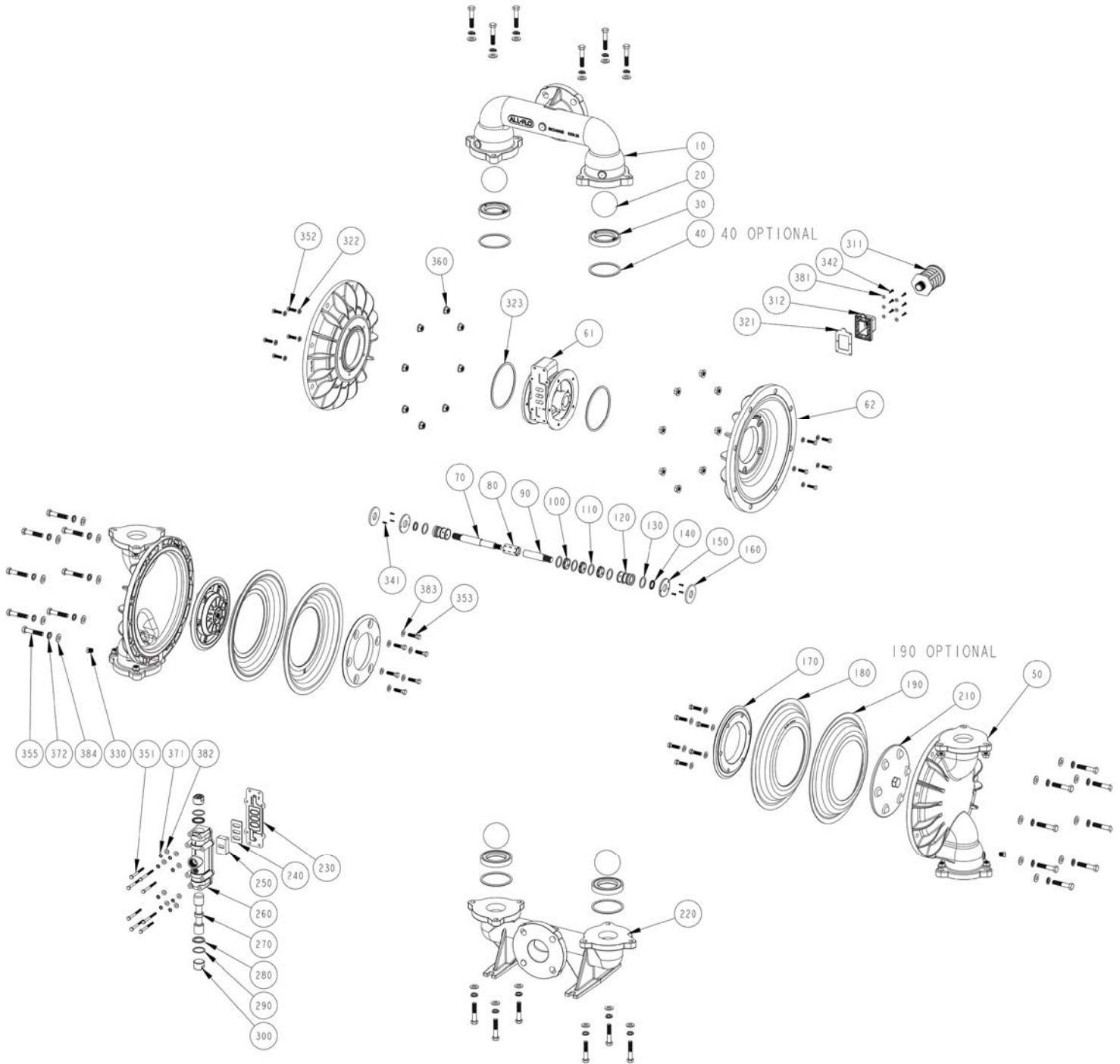

PARTS LIST - STAINLESS STEEL, A300-FA3-****-***

ITEM	DESCRIPTION	QTY	PUMP MODEL	PART NO.	MATERIAL
10	DISCHARGE MANIFOLD	1	A300-FA3-****-***	10511-26	Stainless Steel
20	BALL	4	A300-*A*-*V**_*** A300-*A*-*E**_*** A300-*A*-*G**_*** A300-*A*-*N**_*** A300-*A*-*S**_*** A300-*A*-*T**_***	11007-13 11007-15 11007-19 11007-21 11007-23 11007-45	FKM EPDM Geolast® Buna-N Santoprene® PTFE
30	VALVE SEAT (VALVE SEATS 10905-13, -15 & -19 HAVE INTEGRAL VALVE & O-RING)	4	A300-*A*-*V**_*** A300-*A*-*E**_*** A300-*A*-*N**_*** A300-*A*-*A**_*** A300-*A*-*3**_*** A300-*A*-*Y**_***	10905-13 10905-15 10905-19 10905-20 10905-26 10905-42	FKM EPDM Buna-N Aluminum Stainless Steel Nylon
40	O-RING (VALVE SEAT) (OPTIONAL- ONLY USED WITH VALVE SEATS 10905-20, -26 & -42)	4	A300-*A*-*N**_*** A300-*A*-*V**_*** A300-*A*-*E**_*** A300-*A*-*T**_***	11934-11 11934-13 11934-15 11934-17	Nitrile FKM EPDM PTFE
50	OUTER CHAMBER	2	A300-FA3-****-***	10704-A300-26	Stainless Steel
61	INTERMEDIATE	1	All Models	11520-A300-20	Aluminum
62	INNER CHAMBER	2	All Models	11802-A300-20	Aluminum
70 & 90	DIAPHRAGM ROD ASSEMBLY	1	A300-FA3-****-***	35007-00	Stainless Steel
80	PILOT SLEEVE	1	All Models	10106-31 Δ	Acetal
100	INNER SPACER, PILOT SLEEVE	3	All Models	10205-40 Δ	Polypropylene
110	O-RING (PILOT SLEEVE SPACER)	4	All Models	11919-16 Δ	Urethane
120	END SPACER, PILOT SLEEVE	2	All Models	10206-40 Δ	Polypropylene
130	O-RING (END SPACER)	2	All Models	11919-11 Δ	Nitrile
140	LIP SEAL (AIR VALVE)	2	All Models	12002-76 Δ	Nitrile
150	RETAINING PLATE	2	All Models	12712-A300-20	Aluminum
160	BUMPER	2	All Models	12309-16	Urethane
170	INNER DIAPHRAGM PLATE	2	All Models	11107-20	Aluminum
180	DIAPHRAGM (BACKUP)	2	A300-*A*-*N***_*** A300-*A*-*V***_*** A300-*A*-*E***_*** A300-*A*-*G***_*** A300-*A*-*S***_*** A300-*A*-*T***_***(PTFE)	10608-11 10608-13 10608-16 10608-19 10608-23 10608-23	Buna-N FKM Urethane Geolast® Santoprene® Santoprene®
190	OVERLAY (PTFE ONLY)	2	A300-*A*-*T***_***	11407-59	PTFE
200	N/A				
210	OUTER DIAPHRAGM PLATE	2	A300-FA3-****-***	11222-26	Stainless Steel
220	SUCTION MANIFOLD	1	A300-FA3-****-***	10510-26	Stainless Steel
230	GASKET, AIR VALVE	1	All Models	12115-19 ‡	Nitrile
240	SHUTTLE PLATE	1	All Models	10414-26 ‡	Stainless Steel
250	SHUTTLE	1	All Models	10413-32 ‡	Special
260	AIR VALVE BODY	1	All Models	11613-20 ‡	Aluminum
270	AIR VALVE SPOOL	1	All Models	10412-31 ‡	Acetal
280	LIP SEAL (DIAPHRAGM ROD)	2	All Models	12003-76 ‡	Nitrile

PARTS LIST - STAINLESS STEEL, A300-FA3-****-***

ITEM	DESCRIPTION	QTY	PUMP MODEL	PART NO.	MATERIAL
290	O-RING (AIR VALVE END PLUG)	2	All Models	11913-11 ‡	Nitrile
300	AIR VALVE END PLUG	2	All Models	11706-20 ‡	Aluminum
311	MUFFLER	1	All Models	13001-00	Polypropylene
	OPTIONAL - PREMIUM METAL		Optional	13009-00	Aluminum
			A300-*A*-****-*Z*; Z=4, 8, C, E, G, I	13010-00	Aluminum
312	MUFFLER PLATE	1	All Models	13107-60	Polypropylene
	OPTIONAL - PREMIUM METAL		A300-*A*-****-*Z*; Z=4, 8, C, E, G, I	13107-20-125	Aluminum
321	MUFFLER GASKET	1	All Models	12108-11	Nitrile
322	WASHER, SEALING	10	All Models	12352-26	Stainless Steel
323	O-RING (CHAMBER/INTERMEDIATE)	2	All Models	11956-11	Nitrile
330	PIPE PLUG	2	A300-FA3-****-***	12205-26	Stainless Steel
341	SCREW, PHILLIPS FLAT HEAD (#6-32 X 1/2")	6	All Models	12550-050-MS-26	Stainless Steel
342	SCREW, PHILLIPS PAN (#8-32 X 3/4" (1-1/8")	6	All Models	12531-075-MS-26	Stainless Steel
	OPTIONAL - PREMIUM METAL		A300-*A*-****-*Z*; Z=4, 8, C, E, G, I	12531-113-26	Stainless Steel
351	CAP SCREW (1/4" -20 X 3")	8	A300-FA3-****-***	12516-26	Stainless Steel
352	CAP SCREW, HEX HEAD (5/16" -18 X 1")	10	All Models	12537-26	Stainless Steel
353	CAP SCREW (3/8" -16 X 1-1/4")	12	All Models	12534-25	Plated Steel
355	CAP SCREW (1/2" -13 X 2-1/2")	28	A300-FA3-****-***	12522-26	Stainless Steel
360	NUT, FLANGE (1/2" -13)	28	A300-FA3-****-***	12582-26	Stainless Steel
371	WASHER, LOCK (1/4")	8	A300-FA3-****-***	12350-26	Stainless Steel
372	WASHER, SPLIT LOCK (1/2")	28	A300-FA3-****-***	12323-26	Stainless Steel
381	WASHER (5/32")	6	All Models	12311-26	Stainless Steel
382	WASHER (1/4")	8	A300-FA3-****-***	12300-26	Stainless Steel
383	WASHER (3/8")	12	All Models	12303-25	Plated Steel
384	WASHER (1/2")	28	A300-FA3-****-***	12306-26	Stainless Steel
390	N/A				
400	GROUNDING LUG (NOT SHOWN)	1	Optional	13480-20	Aluminum
	Magnalube .75 OZ.		As Required, All Models	13404-00	Grease
* Any Character					
‡ , Δ Only sold as part of assembly					

ASSEMBLY PART NUMBERS	PUMP MODEL	PART NO.	MATERIAL
‡ PILOT VALVE ASSEMBLY 80, 100, 110, 120, 130, 140	A300-FA3-****-***	APK-300-A	Various
Δ MAIN AIR VALVE ASSEMBLY 230, 240, 250, 260, 270, 280, 290, 300	A300-FA3-****-***	AMK-300-A	Various

ELASTOMERS

WETTED ELASTOMERS

BUNA-N (NITRILE)

is a general purpose elastomer used with water and many oils. Temperature range 10°F to 180°F (-12°C to 82°C).

GEOLAST®

is an injection molded thermoplastic material with characteristics similar to Nitrile. Has excellent abrasion resistance. Temperature range 10°F to 180°F (-12°C to 82°C).

EPDM

is a general purpose elastomer with good resistance to many acids and bases. Temperature range -40°F to 280°F (-40°C to 138°C).

SANTOPRENE®

is an injection molded material with characteristics similar to EPDM. Has excellent abrasion resistance. Temperature range -40°F to 225°F (-40°C to 107°C).

FKM

is an elastomer with good corrosion resistance to a wide variety of chemicals. Temperature range -40°F to 350°F (-40°C to 177°C).

PTFE (POLYTETRAFLUOROETHYLENE)

is a thermoplastic polymer that is inert to most chemicals. Temperature range 40°F to 220°F (4°C to 104°C).

Most of the above elastomers are available in FDA approved formulations.

Geolast® is a registered trademark of ExxonMobil Chemical Co.

Santoprene® is a registered trademark of ExxonMobil Chemical Co.

Hytrel® is a registered trademark of DuPont Performance Elastomers L.L.C.

Magnalube® is a registered trademark of Carleton-Stuart Corp.



II 2 GD c TX

Warning: The TX marking refers to the maximum surface temperature depending not on the equipment itself, but mainly on operating conditions. In this case, the maximum surface temperature depends upon the temperature of the process fluids.

WARRANTY AND REGISTRATION

WARRANTY. All All-Flo products shall be covered by the standard All-Flo Limited Warranty in effect at the time of shipment. This warranty (which may be modified by All-Flo at any time) provides:

MATERIALS SOLD ARE WARRANTED TO THE ORIGINAL USER AGAINST DEFECTS IN WORKMANSHIP OR MATERIALS UNDER NORMAL USE (RENTAL USE EXCLUDED) FOR FIVE YEARS AFTER PURCHASE DATE. ANY PUMP WHICH IS DETERMINED TO BE DEFECTIVE IN MATERIAL AND WORKMANSHIP AND RETURNED TO ALL-FLO, SHIPPING COSTS PREPAID, WILL BE REPAIRED OR REPLACED AT ALL-FLO'S OPTION. CUSTOMER SHALL NOTIFY ALL-FLO IN WRITING WITHIN 30 DAYS OF ANY CLAIMED DEFECTS. NO MATERIALS CAN BE RETURNED WITHOUT THE PRIOR CONSENT OF ALL-FLO, AND IF APPROVED SHALL BE RETURNED TO ALL-FLO FREIGHT PREPAID. ALL-FLO'S LIABILITY FOR ANY BREACH OF THIS WARRANTY SHALL BE LIMITED TO EITHER REPLACEMENT OF THE MATERIALS OR, AT ALL-FLO'S SOLE OPTION, THE REFUND OF THE PURCHASE PRICE. ALL-FLO SHALL NOT BE HELD LIABLE FOR ANY INCIDENTAL OR CONSEQUENTIAL DAMAGES CAUSED BY BREACH OF THIS WARRANTY. THIS EXCLUSION APPLIES WHETHER SUCH DAMAGES WERE SOUGHT BASED ON BREACH OF WARRANTY, BREACH OF CONTRACT, NEGLIGENCE, STRICT LIABILITY IN TORT, OR ANY OTHER LEGAL THEORY. FURTHER, ALL-FLO SHALL NOT BE LIABLE FOR LOSSES, DELAYS, LABOR COSTS, OR ANY OTHER COST OR EXPENSE DIRECTLY OR INDIRECTLY ARISING FROM THE USE OF MATERIALS. ALL-FLO'S LIABILITY IS EXPRESSLY LIMITED TO THE REPLACEMENT OR REPAIR OF DEFECTIVE GOODS, OR THE TOTAL VALUE OF SUCH GOODS. THIS WARRANTY IS IN LIEU OF ALL OTHER WARRANTIES, WHETHER EXPRESS, IMPLIED, OR ORAL INCLUDING THE IMPLIED WARRANTY OF MERCHANTABILITY, ANY IMPLIED WARRANTY OF FITNESS FOR A PARTICULAR PURPOSE, AND ANY IMPLIED WARRANTIES OTHERWISE ARISING FROM A COURSE OF DEALING OR TRADE. All-Flo will not, in ANY event, be liable for any loss of profit, interruption of business or any other special, consequential or incidental damages suffered or sustained by Customer. All-Flo's total maximum liability to the customer in respect of sale of materials or services rendered by All-Flo is limited to the total monies received by All-Flo from the customer for the particular materials described in Customer's order.

All-Flo does not warrant any part or component that it does not manufacture, but will assign to the original end-user purchaser of any warranty received by it from the manufacturer, to extent such pass through is permitted by the manufacturer



REGISTRATION FORM

Pump Model _____ Pump Serial Number _____

Company Name _____

Name _____ Email _____

Phone # _____ City _____ State _____ Zip _____

Qty of Pumps _____ Fluid Pumping _____

How did you hear about us? Existing All-Flo user,
Web, Distributor, Magazine...



Scan QR code and
complete form
on mobile phone
or visit

MAIL TO: All-Flo | Attn: Product Registration
22069 Van Buren Street, Grand Terrace, CA 92313-5651

www.all-flo.com/registration-form.html



PSG

22069 Van Buren Street

Grand Terrace, CA 92313-5651 USA

P: +1 (440) 354-1700 F: +1 (440) 354-9466

all-flo.com

All-Flo is committed to the pursuit of designing and manufacturing the highest quality product available to industry. Since the beginning in 1986, All-Flo engineers have used their extensive knowledge of today's engineered materials, advanced air system logic and manufacturing techniques to develop the superior group of lube-free, air-operated diaphragm pumps found in this catalog. Every pump is performance engineered and quality built to provide trouble-free service under the toughest conditions.



Where Innovation Flows