

# IOM

INSTALLATION OPERATION  
& MAINTENANCE

## D038 - D200

PLASTIC AND CONDUCTIVE PLASTIC  
3/8, 1/2, 1, 1-1/2, AND 2 INCH  
AIR-OPERATED DOUBLE-DIAPHRAGM PUMPS

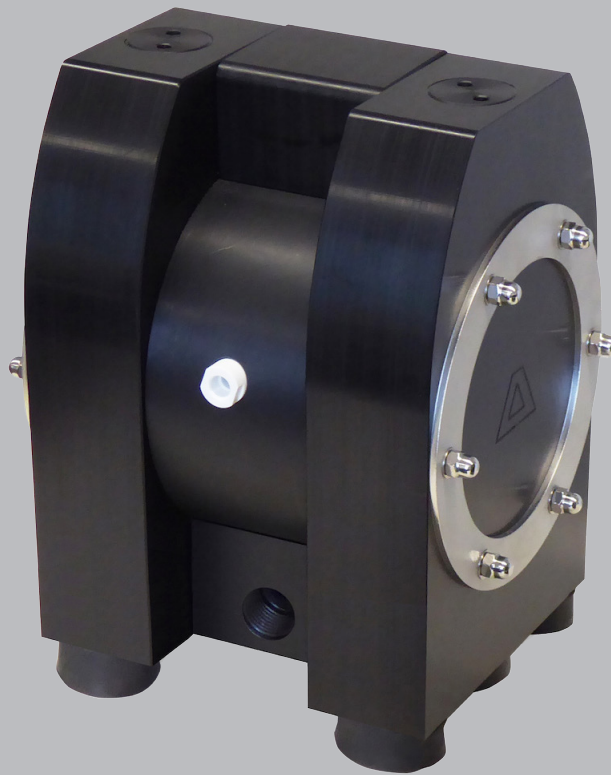

# TABLE OF CONTENTS

SECTION 1	WARNINGS, DANGERS AND CAUTIONS	3
SECTION 2	MODEL DESIGNATION MATRIX	4
SECTION 3	PRINCIPLES OF OPERATION	5
SECTION 4	DIMENSIONAL DRAWINGS	6
SECTION 5	PERFORMANCE CURVES	
	D038, D050, D100, D150, D200 .....	7
SECTION 6	INSTALLATION,	
	INSTALLATION AND OPERATION .....	9
	TROUBLESHOOTING .....	13
	MAINTENANCE .....	15
SECTION 7	REPAIR AND ASSEMBLY	
	DISASSEMBLY .....	16
	ASSEMBLY .....	17
SECTION 8	EXPLODED VIEWS AND PARTS LISTS	18-19
SECTION 9	ELASTOMERS AND REPAIR KITS	20
SECTION 10	WARRANTY AND REGISTRATION	21

# CAUTIONS — READ FIRST!

READ THESE WARNINGS AND SAFETY PRECAUTIONS PRIOR TO INSTALLATION OR OPERATION. FAILURE TO COMPLY WITH THESE INSTRUCTIONS COULD RESULT IN PERSONAL INJURY AND OR PROPERTY DAMAGE. RETAIN THESE INSTRUCTIONS FOR FUTURE REFERENCE.

**⚠ WARNING** This product can expose you to chemicals including Nickel, Chromium, Cadmium, or Cobalt, which are known to the State of California to cause cancer and/or birth defects or other reproductive harm. For more information, go to [www.P65Warnings.ca.gov](http://www.P65Warnings.ca.gov).

**⚠ WARNING** Pump, valves and all containers must be properly grounded prior to handling flammable fluids and/or whenever static electricity is a hazard.

**⚠ WARNING** Prior to servicing the pump, ensure that the air and fluid lines are closed and disconnected. While wearing personal protective equipment, flush, drain and process liquid from the pump in a safe manner.

**⚠ WARNING** The temperature marking refers to the maximum surface temperature depending not on the equipment itself, but mainly on operating conditions. In this case, the maximum surface temperature depends upon the temperature of the process fluids.

**⚠ CAUTION** Material temperature limits is as follows:

Polyethylene/Conductive Polyethylene:	158°F (70°C)
PTFE/Conductive PTFE:	176°F (80°C)

Temperature limits are solely based upon mechanical stress and certain chemicals will reduce the maximum operating temperature. The allowable temperature range for the process fluid is determined by the materials in contact with the fluid being pumped. Consult a chemical resistance guide for chemical compatibility and a more precise safe temperature limit. Always use minimum air pressure when pumping at elevated temperatures.

**⚠ CAUTION** Do not lubricate air supply.

**⚠ CAUTION** Do not connect a compressed air source to the exhaust port of the pump.

**⚠ WARNING** Use only with liquid process fluid.

**⚠ WARNING** Maintenance must not be performed when a hazardous atmosphere is present.

**⚠ WARNING** = Hazards or unsafe practices which could result in severe personal injury, death or substantial property damage

**⚠ CAUTION** = Hazards or unsafe practices which could result in minor personal injury, product or property damage.

**⚠ CAUTION** Do not exceed 100 psig (7 bar) air-inlet pressure.

**⚠ CAUTION** Do not operate with a positive suction pressure.

**⚠ CAUTION** Ensure all wetted components are chemically compatible with the process fluid and the cleaning fluid.

**⚠ CAUTION** Ensure pump is thoroughly cleaned and flushed prior to installation into a process line.

**⚠ CAUTION** Always wear Personal Protective Equipment (PPE) when operating pump.

**⚠ CAUTION** Close and disconnect all compressed air and bleed all air from the pump prior to service. Remove all process fluid in a safe manner prior to service.

**⚠ CAUTION** Blow out all compressed air lines in order to remove any debris, prior to pump installation. Ensure that the muffler is properly installed prior to pump operation.

**⚠ CAUTION** Ensure air exhaust is piped to atmosphere prior to a submerged installation or nitrogen gas installation.

**⚠ CAUTION** Ensure all hardware is set to correct torque values prior to operation.

# MODEL DESIGNATION MATRIX

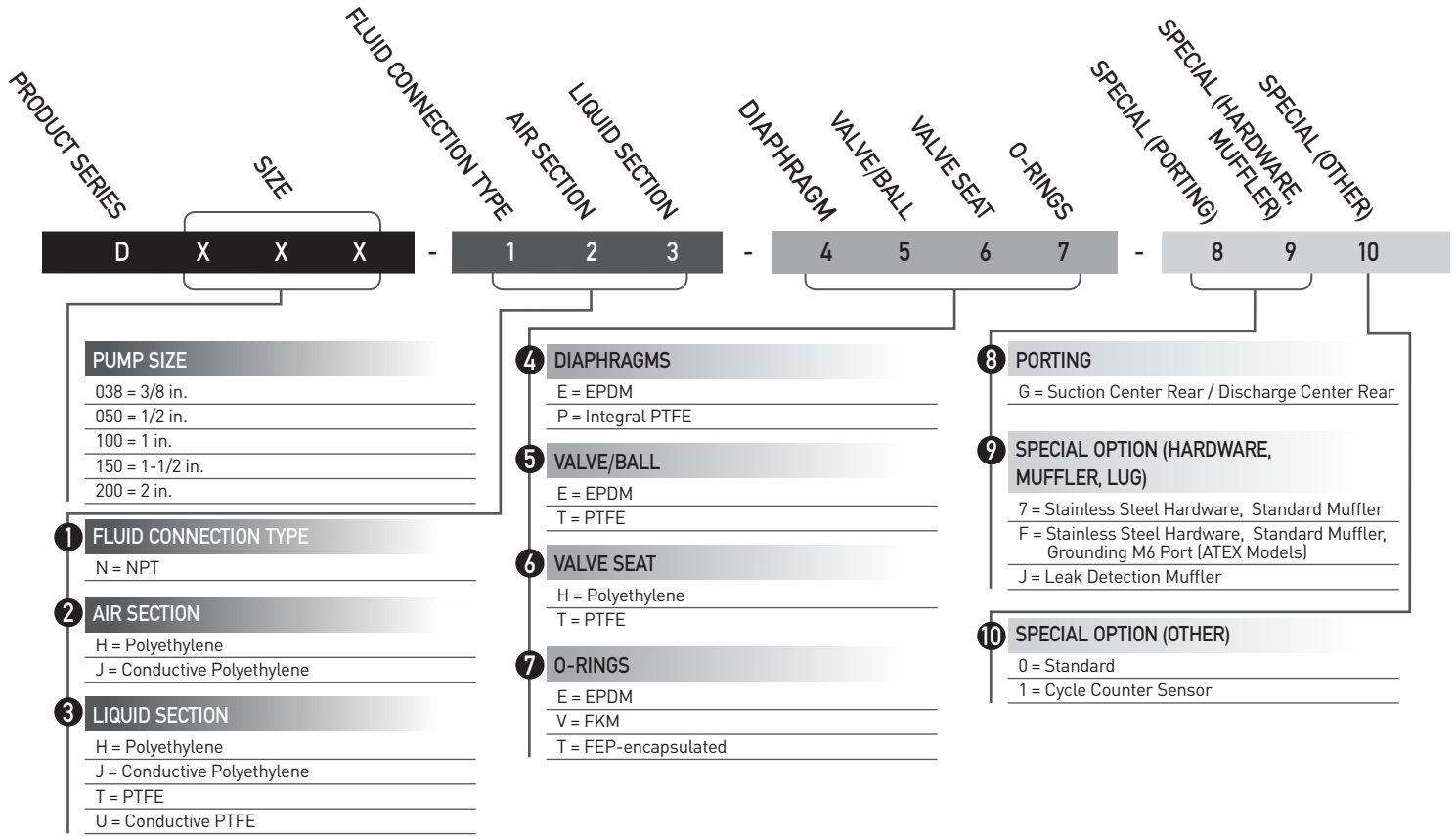

# PRINCIPLES OF OPERATION

## HOW AN AIR OPERATED DOUBLE DIAPHRAGM PUMP WORKS

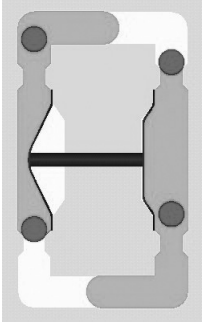

The air-valve directs pressurized air behind the diaphragm on the right, causing the diaphragm on the right to move outward (to the right).

Since both the right diaphragm and the left diaphragm are connected via a diaphragm rod, when the right diaphragm moves to the right, the left diaphragm (through the action of the diaphragm rod) moves to the left also.

When the diaphragm on the left side is moving to the right, it is referred to as suction stroke. When the left diaphragm is in its suction stroke, the left suction ball moves upward (opens) and the left discharge ball moves downward (closes). This action creates suction and draws liquid into the left side chamber.

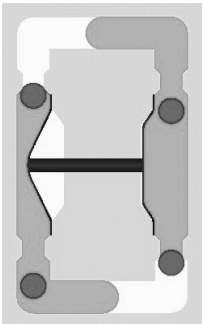

The air-valve directs pressurized air behind the left diaphragm, causing the left diaphragm to move outward (to the left).

Since both the left diaphragm and the right diaphragm are connected via a diaphragm rod, when the left diaphragm moves to the left, the right diaphragm (through the action of the diaphragm rod) moves to the right also.

When the diaphragm on the left side moves outward, the left discharge ball moves upward (opens) and the left suction ball moves downward (closes). This causes the liquid to leave the left side liquid outlet of the pump.

Simultaneously, the right diaphragm moves inward (to the left), which causes the right suction ball to open and the right discharge to close, which in turn causes suction, drawing liquid into the right chamber.

The process of alternating right suction / left discharge (and vice-versa) continues as long as compressed air is supplied to the pump.

# PUMP DIMENSIONS

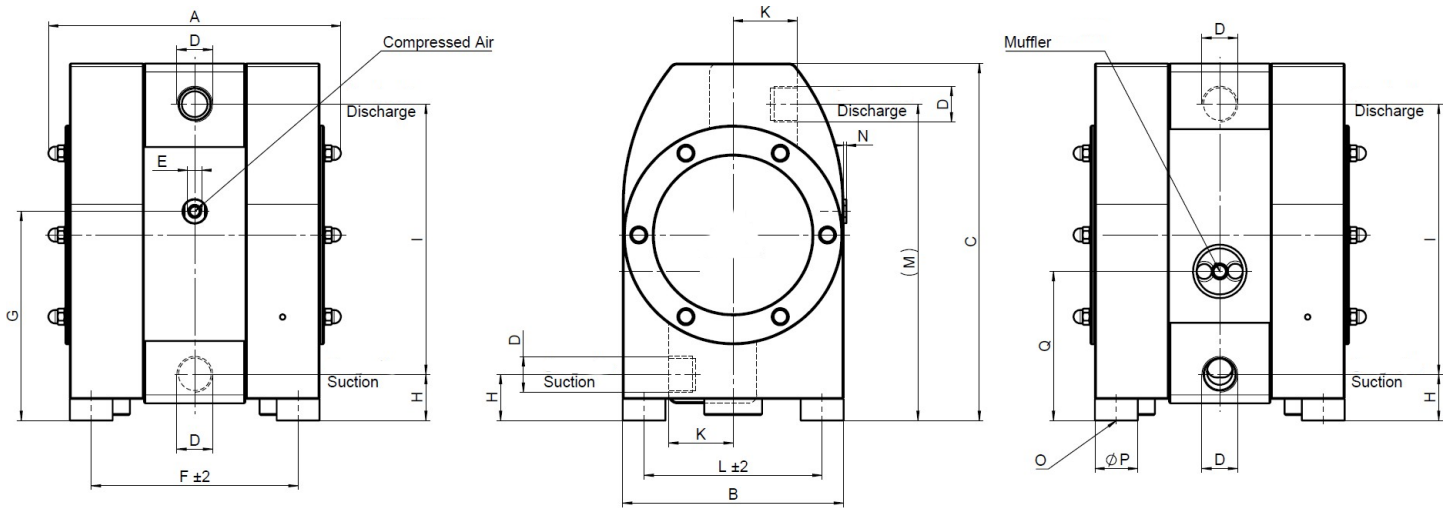

inch	A	B	C	D	E	F	G	H	I	K	L	M	N	O	P	Q
D038	6.1	4.3	7	NPT 3/8"	NPT 1/8"	3.6	3.8	1.1	5.2	1.2	3.1	6.3	-	-	1	3.8
D050	8	6.1	10	NPT 1/2"	NPT 1/4"	5.2	6.1	1.7	7.6	1.8	4.6	9.3	-	M8	1.6	4.2
D100	10.7	8.1	13.1	NPT 1"	NPT 1/4"	7.6	8.5	2.5	9.9	2.4	6.5	12.4	0.1	M8	1.6	6.3
D150	14.5	10.7	19.6	NPT 1-1/2"	NPT 1/2"	10.9	9.3	2.8	13.5	3	8.7	16.4	0.3	M10	2	9.3
D200	17.8	13.9	22.1	NPT 2"	NPT 1/2"	13.9	11.5	3	17.3	3.3	11.9	20.3	0.3	M10	2	11.5

mm	A	B	C	D	E	F	G	H	I	K	L	M	N	O	P	Q
D038	155	110	177	NPT 3/8"	NPT 1/8"	92	96	28	132	30	80	160	-	-	25	96
D050	203	156	253	NPT 1/2"	NPT 1/4"	131	155.5	43	192	46	116	235	-	M8	40	105.5
D100	273	206	333	NPT 1"	NPT 1/4"	193	215	63	252	60	166	315	3	M8	40	159
D150	368	272	448	NPT 1-1/2"	NPT 1/2"	278	235	72	344	75	222	416	7	M10	50	235
D200	452	352	562	NPT 2"	NPT 1/2"	354	291	75	440	83	302	515	7	M10	50	291

# PERFORMANCE CURVES

**D038 PERFORMANCE CURVE**

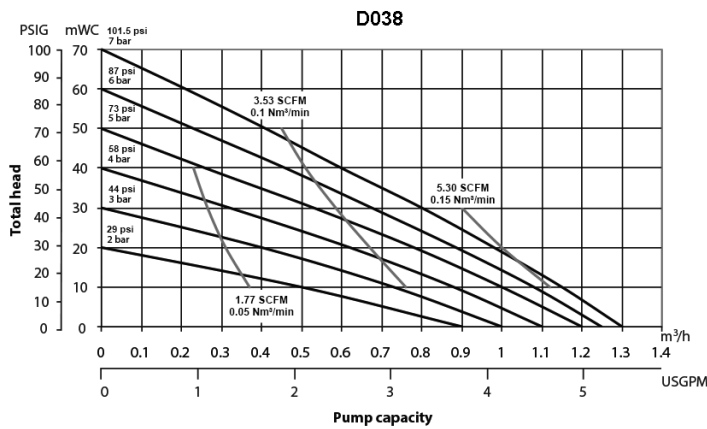

**D038 Performance Specifications**

Max. Flow:	6 gpm (22 lpm)
Max. Air Pressure:	100 psi (7 bar)
Max. Solids:	1/8" (3 mm)
Max. Suction Lift Dry:	3.3 ft-H <sub>2</sub> O (1 m-H <sub>2</sub> O)
Max. Suction Lift Wet:	29.5 ft-H <sub>2</sub> O (9 m-H <sub>2</sub> O)
Weight Polyethylene:	4.4 lbs (2 kg)
Weight PTFE:	8.8 lbs (4 kg)
Air Inlet:	1/8" FNPT
Liquid Inlet FNPT:	3/8"
Liquid Outlet FNPT:	3/8"

**D050 PERFORMANCE CURVE**

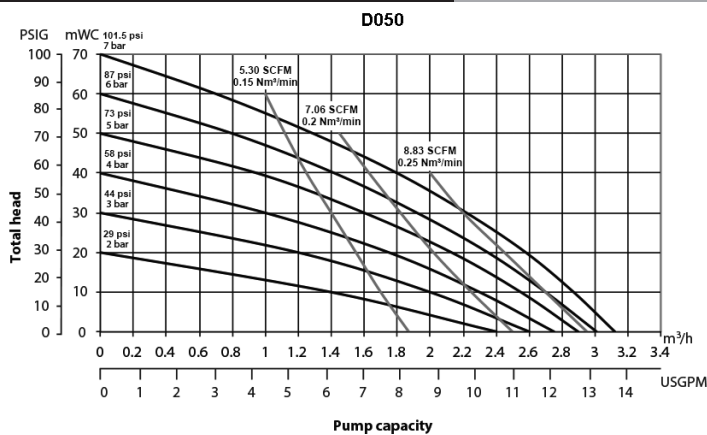

**D050 Performance Specifications**

Max. Flow:	14 gpm (52 lpm)
Max. Air Pressure:	100 psi (7 bar)
Max. Solids:	5/32" (4 mm)
Max. Suction Lift Dry:	6.6 ft-H <sub>2</sub> O (2 m-H <sub>2</sub> O)
Max. Suction Lift Wet:	29.5 ft-H <sub>2</sub> O (9 m-H <sub>2</sub> O)
Weight Polyethylene:	13 lbs (6 kg)
Weight PTFE:	22 lbs (10 kg)
Air Inlet:	1/4" FNPT
Liquid Inlet FNPT:	1/2"
Liquid Outlet FNPT:	1/2"

**D100 PERFORMANCE CURVE**

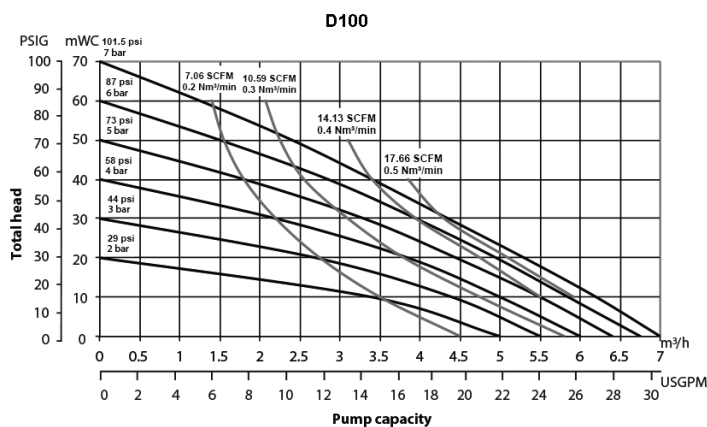

**D100 Performance Specifications**

Max. Flow:	31 gpm (117 lpm)
Max. Air Pressure:	100 psi (7 bar)
Max. Solids:	1/4" (6 mm)
Max. Suction Lift Dry:	9.8 ft-H <sub>2</sub> O (3 m-H <sub>2</sub> O)
Max. Suction Lift Wet:	29.5 ft-H <sub>2</sub> O (9 m-H <sub>2</sub> O)
Weight Polyethylene:	31 lbs (14 kg)
Weight PTFE:	51 lbs (23 kg)
Air Inlet:	1/4" FNPT
Liquid Inlet FNPT:	1"
Liquid Outlet FNPT:	1"

\*Flow rates indicated on the chart(s) shown were determined by pumping water at flooded suction. For optimum life and performance, pumps should be specified so that daily operation parameters will fall in the center of the pump performance curve.

# PERFORMANCE CURVES

## D150 PERFORMANCE CURVE

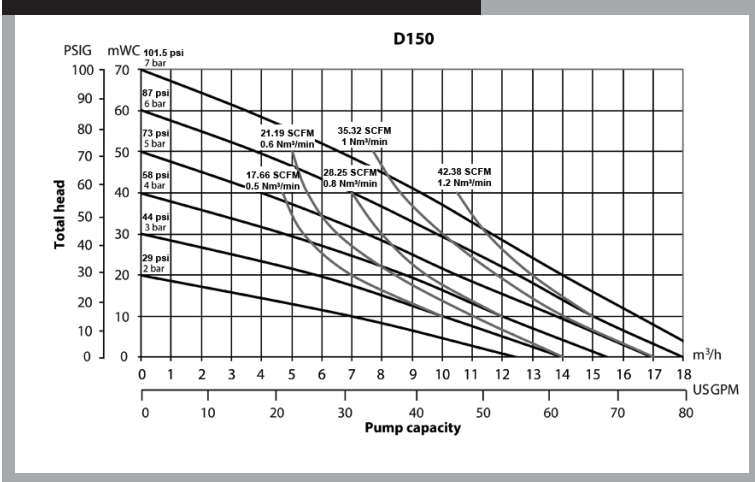

### D150 Performance Specifications

Max. Flow:	80 gpm (300 lpm)
Max. Air Pressure:	100 psi (7 bar)
Max. Solids:	7/20" (9 mm)
Max. Suction Lift Dry:	13.1 ft-H <sub>2</sub> O (4 m-H <sub>2</sub> O)
Max. Suction Lift Wet:	29.5 ft-H <sub>2</sub> O (9 m-H <sub>2</sub> O)
Weight Polyethylene:	66 lbs (30 kg)
Weight PTFE:	126 lbs (57 kg)
Air Inlet:	1/2" FNPT
Liquid Inlet FNPT:	1-1/2"
Liquid Outlet FNPT:	1-1/2"

## D200 PERFORMANCE CURVE

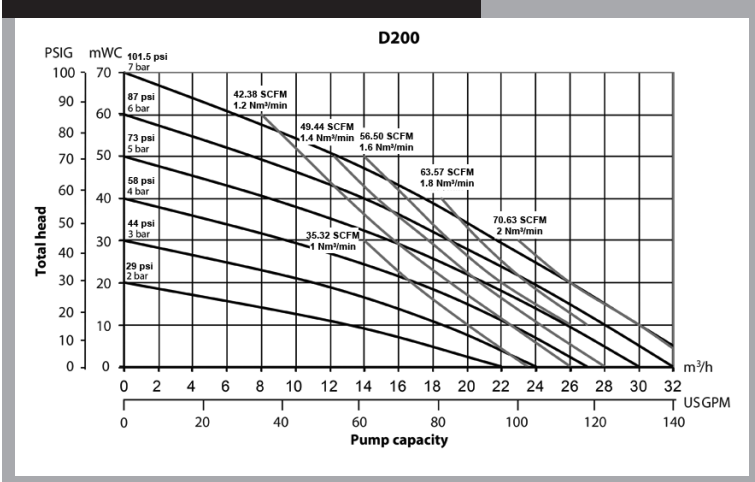

### D200 Performance Specifications

Max. Flow:	140 gpm (530 lpm)
Max. Air Pressure:	100 psi (7 bar)
Max. Solids:	7/16" (11 mm)
Max. Suction Lift Dry:	16.4 ft-H <sub>2</sub> O (5 m-H <sub>2</sub> O)
Max. Suction Lift Wet:	29.5 ft-H <sub>2</sub> O (9 m-H <sub>2</sub> O)
Weight Polyethylene:	126 lbs (57 kg)
Weight PTFE:	229 lbs (104 kg)
Air Inlet:	1/2" FNPT
Liquid Inlet FNPT:	2"
Liquid Outlet FNPT:	2"

\*Flow rates indicated on the chart(s) shown were determined by pumping water at flooded suction. For optimum life and performance, pumps should be specified so that daily operation parameters will fall in the center of the pump performance curve.



# INSTALLATION, TROUBLE-SHOOTING AND MAINTENANCE

For flammable liquids as well as for applications in explosion-proof areas, only pumps with housings and fittings in conductive plastic materials may be used. D Series Pumps with the housing codes J (Conductive Polyethylene) and U (Conductive PTFE) meet this requirement. The pump has to be grounded at the connection to ground provided at the side housing [1]. All other housing parts are connected conductively to each other. D Series pumps made of electrically conductive PE/PTFE are suitable to be used in explosion areas of the category 2 and 3 ("Zone 1" resp. "Zone 2"), atmosphere G/D, which are liable to the guideline 2014/34/EU. Conductive diaphragms (liquid side) are applicable without restrictions for transferring liquids of any explosion-group.

When using non-conductive diaphragm materials, the following exemplary protection measures have to be respected:

- The pump is always used for the transfer of exclusively fluids which are conductive or soluble in water or
- Dry-running is avoided by action steps within the facility and/or its control or
- The system is inertised in case of dry running by nitrogen, water, carbon dioxide etc. when the fluid transfer ends.

Piping systems and product connections have to be grounded separately. To avoid ignition hazards the formation of dust deposits on the pumps must be prevented. In explosion proof areas repair working only after careful inspection of the practicability and only with appropriate tools. For the ATEX marking according to guideline 2014/34/EU please see the attached conformity declaration and the according pump label.

In accordance with the regulations of the EN 13463-3 and DIN EN 13463-5 regarding projected areas pumps constructed of non-conductive materials [housing codes H (PE) and T (PTFE)] may also fully used in category 3 ("Zone 2"), atmosphere G / D. A corresponding labeling of such pumps, while unusual, can be made on request

## INSTALLATION

UV-radiation and elevated temperature by UV-radiation can damage the housing parts of pumps made of PE (Liquid Section H and J). In general, the pump has to be connected load free. Neglecting this causes leakage and maybe even damages. To avoid vibrations and temperature related dimension changes in piping systems, pulsation dampers and compensators are recommended. Before connecting the pump, take the yellow blind plugs out of the suction and discharge manifolds [11/12] as well as the air inlet [17]. The air inlet is located below the bilingual sticker with safety instructions. The connections of All-Flo air-operated diaphragm pumps made of plastic have slightly tapered threads. Use threadseal only sparingly, otherwise the connections could be damaged.

## PIPING

The operator is responsible for an adequately stability and an appropriate fixation of the piping according to the state of the art. To facilitate the installation and maintenance shut off valves should be installed right before and after the pump. The nominal width of the connection pipes has to be chosen in accordance to the connections of the pump. A smaller piping can cause cavitation (suction line) as well as a loss of performance (suction and discharge line). In case the pipe is too big, the dry suction capacity of the pump can decrease. Connect the suction line to the suction manifold [12]. Seal the suction line diligently; hosepipes should be suitably armoured. A suction line continuously rising will prevent the formation of air locks in the line which would affect the suction lift.

## LOCATION

Ensure that the pump is installed in an accessible location, in order to facilitate future service and maintenance.

# AIR

The air inlet [17] is located in the middle of the center block [15]. At delivered, it is covered by a bilingual sticker with safety instructions, which can be easily removed. Before installation, make sure that the air supply pipe is free of solids. To supply the pump with driving air sufficiently, the pipe diameter should match the size of the air inlet. Take care that no dirt or particles can intrude into the pump during the connection, as these can accumulate inside the pump and can cause malfunctions.

The integrated air control system [16] is a precision-control that requires oil-free, dry and clean compressed air for optimal function. If humidity is expected, a water separator or air dryer has to be fitted to protect the pump from blocking by ice. The ideal condition is the dewpoint of air at  $-4^{\circ}\text{F}$  ( $-20^{\circ}\text{C}$ ). In humid surroundings, icing from the outside may occur despite the driving air is dried. If so, a prolonged waste-air-exhaust (ca. 20 inch / 500 mm by pipe or hose) can be helpful. When installing the pump into boards or cabinets, it has to be ensured that cold air does not get caught behind the muffler. In applications with a tendency to freezing at the waste air exhaust, good experiences in practise have been achieved by pre-heating the driving air to increase the distance to the dew point of the air. Doing so, it has to be considered that the driving air temperature generally may not exceed  $122^{\circ}\text{F}$  ( $50^{\circ}\text{C}$ ) to avoid expansion and sticking effects on the air side. This maximum air temperature is a well valid when using a compressor producing warm air which is e.g. often true for truck compressors.

The pressure of the driving air should be limited to the amount required to meet the performance needed. Excessive pressure increases both the air consumption and the wear of the pump. The pump is regulated by tuning the flow rate of the air. For a proper operation at the lower performance range the regulation via a needle valve is recommended. An empty pump has to be driven slowly (e.g. via a needle-valve). The pump starts automatically. D Series pumps are self-priming when dry, thus it is not necessary to fill the suction line of the pump. During slow operation of the pump the dry suction lift is better than during high stroke frequency. The suction lift capacity of a liquid-filled pump, however, is much higher.

# OPERATION

The pump is appropriate for running dry during slow operation. Dry running at high stroke frequency causes premature wear. The pumps can briefly (up to max.

one hour) be operated against a closed discharge line. Throttling on the suction side may damage the pump. When the pump operation has been stopped by a closed discharge, the pressure equilibrium of the diaphragms must be ensured. This can be achieved by keeping the pump connected to the air supply pressure; for longer stoppage, the pump must be released from the pressure within the system on both fluid side and air supply side.

# TORQUE VALUES

Immediately before putting the pump into operation as well as after some hours of pumping, the housing bolts [23] have to be fixed according to the torque data listed below. The valve stops discharge valve [2] and the plugs [8] have to be fixed too, as the elements of construction "settle" as well. As a reminder the air inlet [17] is covered by a corresponding sticker at delivery condition. Fixing all these parts is necessary as well after stoppage periods, at temperature variations, after transport and dismantling the pump. In case of temperature varying between extremes or high temperature difference between the liquid and the surrounding, the housing bolts should be controlled more frequently (interval proposals are available on request). The following schedule shows the recommended torque values of the pump housing bolts:

Size	Material	Torque Value ft lbs (Nm)
D038	PE	4.1 (5.5)
	PTFE	3.3 (4.5)
D050	PE	6.3 (8.5)
	PTFE	4.8 (6.5)
D100	PE	10.3 (14)
	PTFE	8.1 (11)
D150	PE	13.3 (18)
	PTFE	11.1 (15)
D200	PE	17 (23)
	PTFE	14 (19)

# SAFETY INSTRUCTIONS

- Installation, operation, and maintenance by qualified staff only.
- Before start-up of the pump anyone should acquaint oneself with the explanations of the chapter troubleshooting (see pages 13/14). Only by this the defect quickly can be realized and eliminated in case of trouble. Problems which cannot be solved or with an unknown reason should be passed on to the manufacturer.
- Before any maintenance and service procedures arising on the pump or on the optional equipment, the complete installation has to be turned off and protected against accidental turn on. This is possible by a lockable emergency stop for the air supply of the pump. Additional a danger sign against restart should be attached.
- Pressure tests of the plant a pump is included in may only be carried out with the pump disconnected from the pressure on both ports or by using the pressure the pump develops while operating. The load of a pressure in the plant may damage the pump.
- AODD pumps must not be operated with a positive suction pressure.
- Depending on the conditions of operation, the liquid conveyed might escape from the pump through the muffler in case of a diaphragm rupture (in this case muffler has to be replaced). For further safety requirements the optional equipment diaphragm monitoring and barrier chamber system are recommended.
- In case of a diaphragm rupture, it might be possible for the fluid pumped to intrude into the air side of the pump. In very adverse conditions - e.g. pressure within the fluid system during stopped air supply - the fluid might as well find its way into the air supply lines. To protect other devices like pulsation dampers or even pneumatic valves, it is recommended to protect the air supply line accordingly, e.g. via a non-return valve. This would as well avoid polluting the air supply line.
- The state of the muffler has to be inspected regularly, as a blocked muffler can be forced out of the pump. If this happens, damages of properties and/or persons cannot be excluded
- If the product tends to settle, the pump has to be flushed regularly. For larger solids a filter has to be installed in the suction line.
- In case of delivery of hot liquids the wetted pump must not standstill for a longer time, because it could lead to temporary leaks in the valve area and to a blockade of the air control system.
- The relevant effective security advises have to be respected.
- Pools of liquid which appear in the near outer area of the pump have to be inspected on danger potential, if necessary safety measures are to be taken.
- Chemical and biological reactions in the product chamber of the pump (mixture of different substances) and the freezing of the liquid have to be avoided.
- Before starting to disassemble the pump, take care that the pump has been emptied and rinsed. Both ports piping are to be closed and drained if applicable. Further the pump has to be cut off from any energy on the air and product side. If the pump is being deported from the plant, a reference about the delivered liquid has to be attached.
- Please respect the relevant additional security advises, if the pump has been used for aggressive, dangerous or toxic liquids (e.g. suitable protective equipment according to the safety data sheet of the liquid). In case of a diaphragm rupture, it is possible that residues of the liquid remain behind the diaphragms, in the area of the air control system and at the muffler, despite of several flushing processes. Hence, appropriate safety equipment according to the safety data sheet of the liquid is indispensable.
- Before putting the pump back into operation, the tightness of the pump has to be checked.
- Air-operated diaphragm pumps can lead to bruises when lifting, sinking or assembling them. Appropriate accessories and safety equipment are to be used. Big and heavy modules have to be fixed and secured to lifting gears when transporting/replacing them.
- Especially when deliver critical liquids, wear parts, like diaphragms, should be replaced within a preventive maintenance.
- The use of non-original All-Flo spare parts and structural changes lead to the lapse of the warranty immediately. When operating such a pump, damages of properties and/or persons cannot be excluded.
- The operation of the pump with nitrogen as driving gas is possible. In closed rooms sufficient ventilation must be provided.
- Possible electrical connections (e.g. when using optional equipment with controllers) may be executed by a qualified person only. The regulations of the respective manufacturers are to be followed.
- At any work arising it has to be made sure that no explosive atmosphere can appear. Appropriate safety equipment is recommended.
- The pump is tested with water before shipment. Water residues inside the pump cannot be precluded. If the liquid, which is wanted to be conveyed, potentially interacts with water, please consult All-Flo.

# SUBMERGED OPERATION

Consider the following advises when using a D Series pump as a submersible pump: When immersing an air-operated diaphragm pump, it must generally be ensured that the waste air is deducted above the fluid level with a pipe or similar. The pump must be located vertically upright to guarantee proper function. Minute leakage on the air inlet or outlet can block the air valve. The pump must be disconnected from the pressure within the system during standstill. When choosing the pump type, it must be taken into consideration that all external parts - even those non-wetted during standard operation - like covers, shock absorbers, connections etc. must be resistant to the fluid pumped. Please consider as well that depending on the material, the pump must be weight down resp. fixed. to achieve ATEX rating and it is recommended to configure the pump with a grounding lug option.

# ADDITIONAL TEMPERATURE CONSIDERATIONS

The temperature and pressure limitations listed on page 3 are solely based on mechanical temperature limits of the housing material used. Depending on

the fluid pumped, the maximum safe operating temperature of the housing material can be reduced significantly.

A general aspect of lower temperatures is, that below 32°F (0°C) cold-brittling of the elastomers used within the pumps can result in accelerated wear. Regarding the housing materials, please note that PE keeps its mechanical strengths at low temperatures and PTFE keeps mechanically stable as well for an extended temperature range. Moreover, freezing, bogging or crystallisation of the fluid pumped must be avoided, especially within the pump. Emptying the pump via the drainage system (optional equipment) may be a useful tool to assist this.

Please consider, that viscosity and specific gravity of most fluids change with temperature (most often increasing at lower temperature). Depending on the application, this fact may not only result in result in a reduced flow rate, the pump may even be unable to prime the thicker and/or "heavier" fluid any more.

# SUGGESTED INSTALLATION

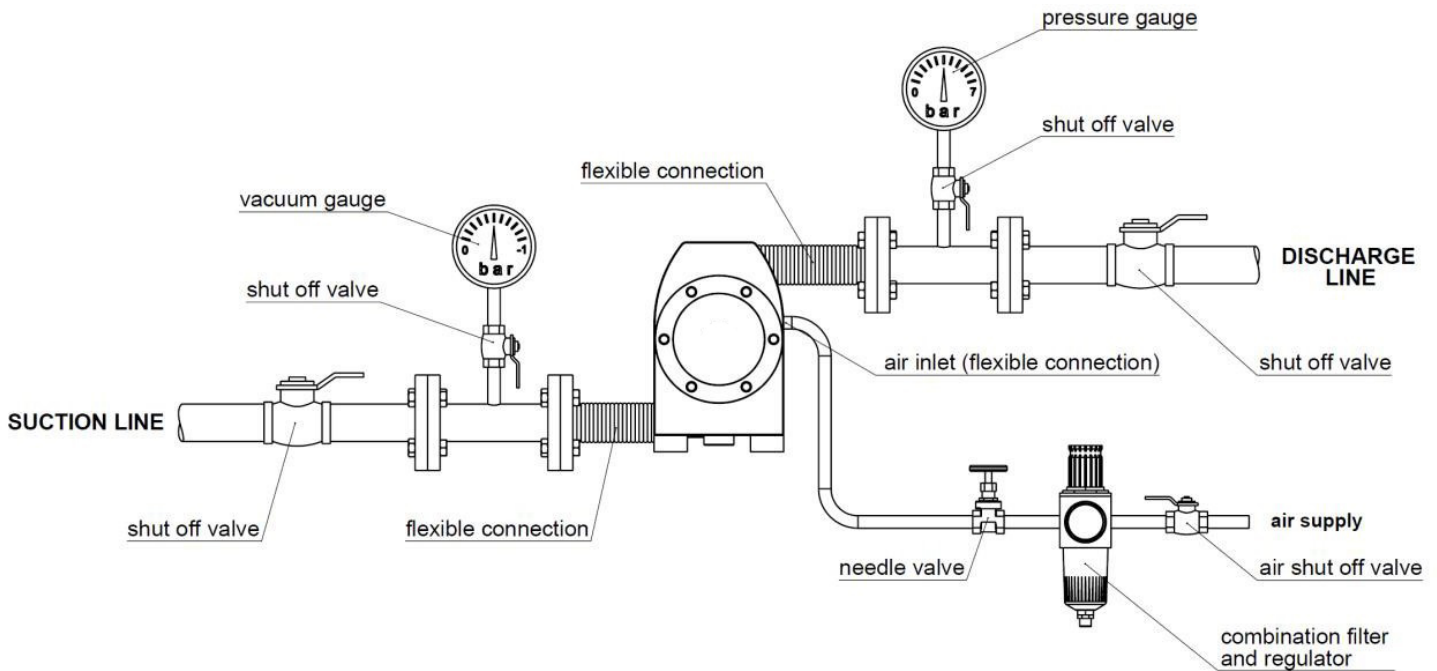

This illustration is a generic representation of a D Series air operated double-diaphragm pump.

# TROUBLESHOOTING

<b>Problem</b>	<b>Possible Reason</b>	<b>Solutions/Remarks</b>
pump does not operate	air supply line blocked/closed muffler blocked working chambers blocked air control system defective discharge line blocked/closed	open air supply clean/replace muffler remove blockage replace air valve system clean/open line
pump operates unsteadily	piston rings worn air control system worn diaphragm rupture air control system soiled check valve blocked icing	replace piston rings replace air control system replace diaphragm, clean pump clean/replace air control system cleaning, removal of bulk particles improve air processing
air within liquid	suction line leaky container with liquid empty diaphragm rupture cavitation	seal suction line fill/new container replace diaphragm adapt suction lift, possibly install suction pressurized air chamber
insufficient discharge pressure	insufficient pressure/amount of driving air air supply line leaky air control system leaky check valve worn more air consuming components	increase air supply  check/repair air supply replace air control system check/replace check valve increase pressure/amount of air
output decreases	air control system soiled icing air pressure drop suction line/inlet strainer soiled discharge line/outlet strainer soiled muffler blocked check valve worn change in viscosity more air consuming components	clean/replace air control system improve air processing: dryer/filter ensure sufficient supply of air cleaning cleaning replace the muffler replace valve change back/adjust pump increase pressure/amount of air
pump stops itself	icing of the air control system  air pressure too low air pressure drop discharge line blocked air filter blocked valve closed air control system defective wear/leaking of air control system diaphragm rupture check valve blocked/worn	Improve air processing: dryer/heater etc.  increase air pressure ensure sufficient air supply clean discharge line clean air filter open valve replace air control system replace air control system replace diaphragm, clean pump clean/replace check valve

# TROUBLESHOOTING

Problem	Possible Reason	Solutions/Remarks
pumps operates, however suction capacity insufficient	<p>pump operates too fast</p> <p>operation beyond physical limits</p> <p>cavitation</p> <p>operation beyond pump capacity</p> <p>air cushion within suction/discharge line</p> <p>dry suction against discharge pressure</p> <p>valve filter within suction line closed</p> <p>valve filter within discharge line closed</p> <p>container with liquid empty</p> <p>vacuum inside the container</p> <p>wear of the check valves</p> <p>suction line leaky</p> <p>suction line blocked</p> <p>air pressure cushion at discharge</p> <p>check valve blocked</p>	<p>start more slowly</p> <p>adjust installation</p> <p>check, cool down</p> <p>adjust installation resp. install bigger pump</p> <p>bleed the line</p> <p>wet pump, start without pressure</p> <p>open valve/clean filter</p> <p>open valve/clean filter</p> <p>fill/new container</p> <p>bleed container</p> <p>replace valves</p> <p>seal suction line</p> <p>clean suction line</p> <p>bleed discharge line</p> <p>clean/replace valve</p>
insufficient suction capacity after pump repair	<p>connections tighten incompletely</p> <p>check valves inserted falsely</p>	<p>tighten/seal connections</p> <p>correct positioning of check valves</p>
diaphragm overstrained	<p>pressure within the plant/system</p> <p>inadmissible vacuum</p> <p>icing</p>	<p>ensure that pressure is only developed by the pump itself, check plant/valves, replace diaphragms</p> <p>check suction line, open valve</p> <p>improve air processing</p>
leaking between housing parts	<p>housing bolts loosened</p> <p>O-rings sleeve damaged</p> <p>diaphragms attacked chemically</p> <p>diaphragms overstrained</p> <p>tension installation/pipework</p>	<p>tighten bolts, check pump</p> <p>replace O-rings</p> <p>replace diaphragms</p> <p>replace diaphragms</p> <p>loosen, eliminate tension, use of a compensator</p>
muffler grey	driving air too humid, icing	improve quality of driving air
muffler black	soiled, oily air	improve quality of driving air, install sensitive filter in suction line
pump is connected to air but does not operate	<p>air control system blocked bulk particles/dirt</p> <p>chemical influence (O-rings swollen)</p> <p>valve closed in discharge line</p>	<p>clean/replace air control system</p> <p>clean pump, replace necessary parts, improve air quality</p> <p>check, replace damaged parts</p> <p>open valve</p>
liquid leaves the pump via the muffler	diaphragm rupture	replace diaphragms, clean pump

# MAINTENANCE

Due to the unique nature of each application, periodic inspection of the pump is the best method to determine a proper maintenance schedule. A record should be kept of all repairs made to an installed pump. This will serve as the best predictor of future maintenance.

Typical maintenance involves replacing of “wear-parts” such as the diaphragms, balls, valve seats and O-rings. Proper maintenance can ensure trouble-free operation of the pump. Refer to repair and assembly instructions for further details.

**⚠ WARNING** Maintenance must not be performed when a hazardous atmosphere is present.

# MAINTENANCE SCHEDULE

## WEEKLY (OR DAILY)

Make a visual check of the pump. If pumped fluid is leaking out of the pump, pipe fittings or muffler turn off pump and schedule maintenance.

## EVERY THREE MONTHS

Inspect fasteners and tighten any loose fasteners to recommended torque settings.

Schedule pump service based on pump’s service history.

	Tool List	Pump Size	D038	D050	D100	D150	D200
Item	Description	Tool	Tool Size				
2	Valve stop, discharge valve	Face pin spanner wrench	5 mm	6 mm	8 mm	8 mm	10 mm
5	Valve seat	All-Flo Tool*	2 10 901 10	2 15 901 10	2 25 901 10	2 40 901 10	2 50 901 10
7	Thread bolt	Slot screwdriver	0.8 x 5.0	0.8 x 5.0	1.0 x 5.5	1.6 x 8.0	1.6 x 8.0
8	Plug, side housing	Face pin spanner wrench***	5 mm	6 mm	8 mm	8 mm	10 mm
16	Air control system	All-Flo Tool** and ring wrench	1 08 901 54 19 mm	1 15 901 54 24 mm			
17	Air inlet	Open-end spanner	13 mm	19 mm	19 mm	27 mm	27 mm
19	Set screw, shaft	Allen key	-	5 mm	6 mm	8 mm	10 mm
23	Housing bolt, cpl.	Open-end spanner/ring wrench/socket wrench	8 mm	10 mm	13 mm	13 mm	17 mm

# MAINTENANCE TOOLS

The general design of D Series pumps is simple. We recommend to take the explosion view in hand to identify the parts by item number that is mentioned in the following. Each pump is delivered a metallic tool to (dis-)assemble the ball valve seats [5]. For the (dis-)assembly of the air valve [16], we recommend to use the special plastic mounting tool that comes with each spare part kits (and on request). Further special tools are not required.

\*Supplied with each pump

\*\*Supplied with each spare part kit

\*\*\*Example



# REPAIR AND ASSEMBLY

## DISASSEMBLY

Refer to the exploded view and BOM list on page \_ and \_ for reference. Among the different sizes of the D Series Pumps, only the number of housing bolts [23] vary. For model D038, the shaft [18] functions as the pilot piston for the air-valve. In D038 pumps, there are no shaft piston rings [20] nor set screws [19]. Please keep these differences in construction in mind when reading the following dismantling instructions.

Unscrew the housing bolts [23] on one side using two (socket) wrenches, remove tension disc [22] first and side housing [1] thereafter. Work carefully to ensure that the sealing surfaces in contact to the diaphragms are not damaged. Carefully draw the housing bolts [23] out of the pump and remove the second tension disc [22]. The centre housing [15]. Both side housings [1] and both manifolds [11/12] are removable now. Remove the manifold-O-rings [13] out of the side housings [1] for a possible renewal.

For further dismantling of the side housings [1], screw out the valve stop, discharge valve [2] with a face spin spanner wrench (figure 13.1).

Alternatively, you can stick two housing bolts [23] into the holes in the valve stop [2] and loosen the valve stop with a third housing bolt [23] fixed in between the others. Take out the ball valve [4] and the O-ring, valve stop, discharge valve [3].



FIGURE 13.1

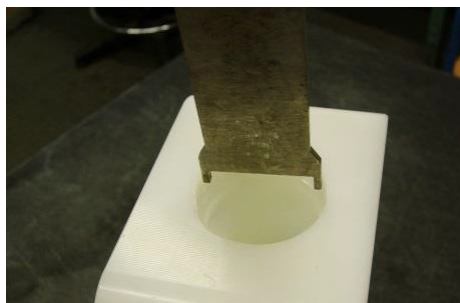

FIGURE 13.2

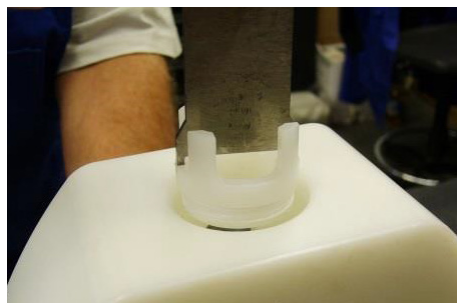

FIGURE 13.3

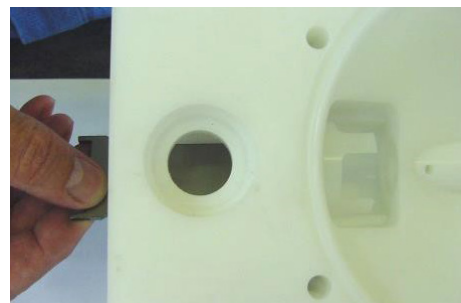

FIGURE 13.4

Use the metallic mounting tool to unscrew the valve seat [5] (figure 13.2/13.3). The plug, side housing [8] can be unscrewed the same way as described for the valve stop [2]. Take care of O-ring plug side housing [9]. Loosen the thread bolt [7] with a slot screwdriver. Remove lock bolt [6] and afterwards valve ball [4]. Turn the mounting tool and screw the valve seat [5] into the side housing [1] (figure 13.4). The valve seat [5] can now be removed from inside the side housing.

Screw one diaphragm [14] left-turning off the shaft [18] and pull the other diaphragm [14] together with the shaft [18] out of the center block [15]. Take out set screws shaft [19] of the diaphragms [14] by using an Allen key (figure 13.5). Remove both parts of the shaft piston rings [20] from their grooves carefully (figure 13.6); do not damage the edges in the center housing, a re-assembly of the same piston rings is impossible, they have to be replaced. Unscrew the muffler [21] and the air inlet [17] out of the center block [15]. To remove the air control system [16], screw off both end caps – bets by using the All-Flo plastic mounting tool (figure 13.7). Take out main and pilot piston. Push out the air valve housing with the mounting tool turned around (figure 13.8).



FIGURE 13.5



FIGURE 13.6



FIGURE 13.7



FIGURE 13.8



# REPAIR AND ASSEMBLY

## ASSEMBLY

The re-assembly of the components is principally carried out vice-versa to the dismantling. Here are some additional references.

For the installation of the air control system [16], first screw in one end cap flushly into the center block [15]. Insert one of the six O-rings air-valve housing into the end cap from the inside. Moisture the four O-rings of the air-valve housing with a bit of water and push the housing into the center block [15] using the mounting tool. Take care that it slips in softly. Do never insert the housing violently with a hammer. In case the housing cocks or hardly gets in, take it out again completely and start again. Insert the main piston and the pilot piston. Lay the sixth O-ring on the edge of the air valve housing and screw in the second end cap.

To assemble new piston rings [20] (pump sizes D038 - D200 only), carefully shape them like kidneys with snap ring pliers and insert the rings into the grooves in the center block [15] (figure 14.1); completely press the rings into the grooves smoothly using some round tool.

Screw the set screws [19] into the diaphragms and tighten them. Fix the diaphragms [14] completely into the shaft [18] with the set screws [19]. Adjust the bores in the center block [15] to the diaphragm on both sides (turn slightly backwards if necessary). The sealing surfaces of the diaphragms and the side housings [1] have to be absolutely clean and undamaged; mere small scratches can cause leaking (if necessary, smoothen the housing surfaces carefully with fine sandpaper).

Cautiously push the O-rings manifold [13] into the side housings [1] (avoid bending the rings by all means! If necessary, moisture and softly twist the rings). When installing the valve stop, discharge valve [2] always start with inserting the O-ring, valve stop discharge valve [3] into the side housing [1] carefully, do NOT shove the O-ring onto the valve stop [2]. It has to be ensured that the O-ring is in direct flat contact to the horizontal surface at the end of the thread (press in with an appropriate round stick if necessary). Afterwards insert lock bolt [6] and bolt together with the thread bolt [7]. Shove the shaft [18] on which one diaphragm [14] is mounted with set crew [19] into the center block [15], lay the side housing [1] and the tension disc [22] onto the diaphragm and fix its position with housing bolts [23]. After that, screw the other diaphragm [14] with set screw [19] onto the shaft [18] and carefully push the housing bolts [23] completely through the center block [15] [slightly turning the bolts helps them to find their way].

Adjust the second side housing [1] and the tension disc [22]. Fix the housing bolts [13] crosswise evenly according to the given torque values until the side housings [1] are situated on the center block [15]. Any further tightening of the bolts does not improve sealing but can deform the housing! Before putting the pump back into operation, the tightness of the pump has to be checked.



FIGURE 14.1

# EXPLODED VIEW & PARTS LIST

D Series D038: pos. 23 = 4 pcs., without pos. 18, 19, 20  
 D Series D050/D100: pos. 23 = 6 pcs.  
 D Series 150/200: pos. 23 = 8 pcs.

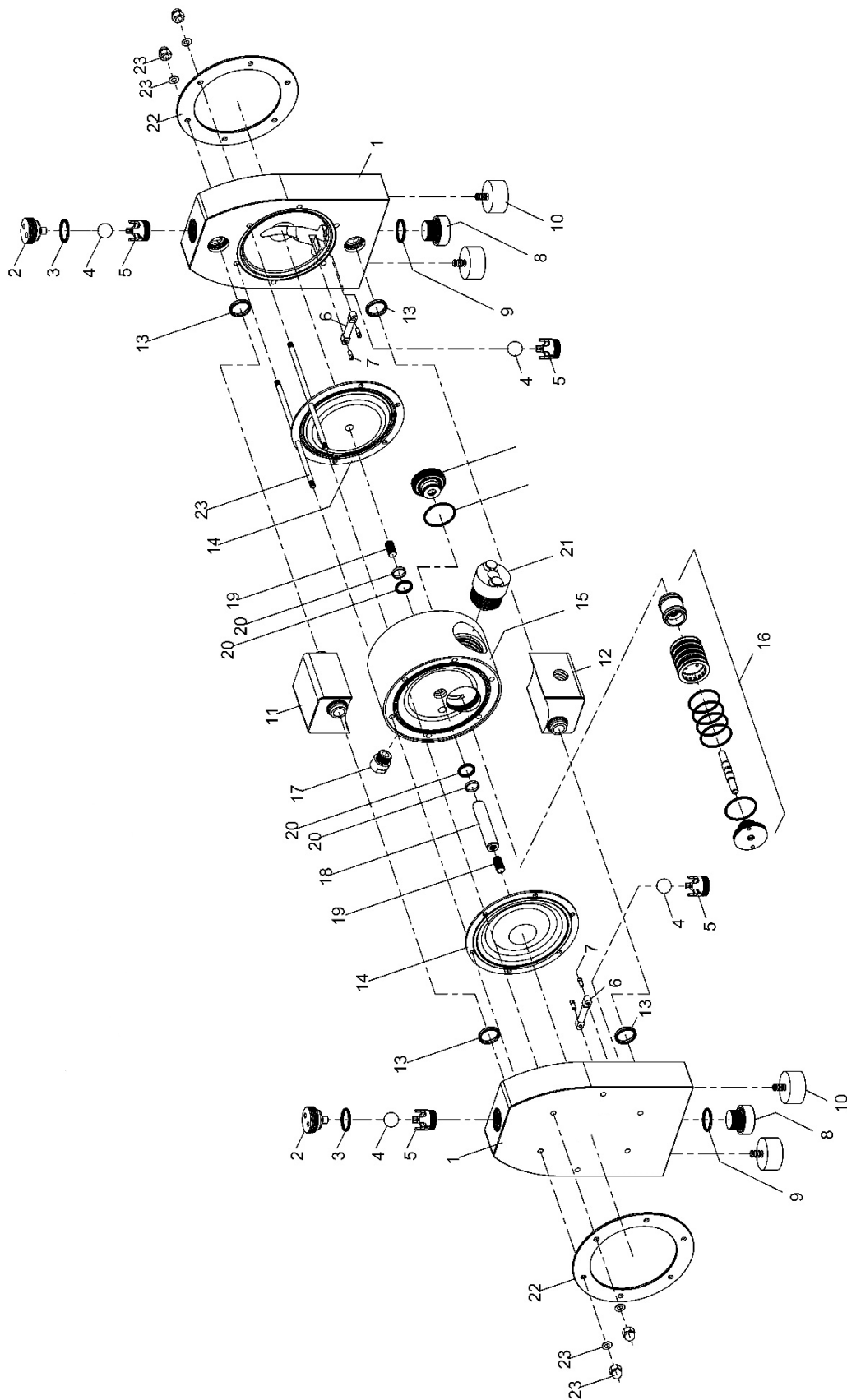

# PARTS LIST

PUMP SIZE				D038	D050	D100	D150	D200
ITEM	PC.	DESCRIPTION	MATERIAL	PART NUMBER				
1	2	SIDE HOUSING, LIQUID SECTION H	PE	17 10 010 51	17 15 010 51	17 25 010 51	17 40 010 51	17 50 010 51
		SIDE HOUSING, LIQUID SECTION J	PE CONDUCTIVE	17 10 010 55	17 15 010 55	17 25 010 55	17 40 010 55	17 50 010 55
		SIDE HOUSING, LIQUID SECTION T	PTFE	17 10 010 60	17 15 010 60	17 25 010 60	17 40 010 60	17 50 010 60
		SIDE HOUSING, LIQUID SECTION U	PTFE CONDUCTIVE	17 10 010 65	17 15 010 65	17 25 010 65	17 40 010 65	17 50 010 65
2	2	VALVE STOP DISCHARGE VALVE, LIQUID SECTION H	PE	7 10 015 51	7 15 015 51	7 25 015 51	7 40 015 51	7 50 015 51
		VALVE STOP DISCHARGE VALVE, LIQUID SECTION J	PE CONDUCTIVE	7 10 015 56	7 15 015 56	7 25 015 56	7 40 015 56	7 50 015 56
		VALVE STOP DISCHARGE VALVE, LIQUID SECTION T	PTFE	7 10 015 60	7 15 015 60	7 25 015 60	7 40 015 60	7 50 015 60
		VALVE STOP DISCHARGE VALVE, LIQUID SECTION U	PTFE CONDUCTIVE	7 10 015 65	7 15 015 65	7 25 015 65	7 40 015 65	7 50 015 65
3	2	O-RING, VALVE STOP DISCHARGE VALVE, DIAPHRAGMS E, O-RINGS E	EPDM	9 19 624 72	9 24 625 72	9 38 626 72	9 57 627 72	9 76 628 72
		O-RING, VALVE STOP DISCHARGE VALVE, DIAPHRAGMS P, O-RINGS V	FKM	9 19 624 75	9 24 625 75	9 38 626 75	9 57 627 75	9 76 628 75
		O-RING, VALVE STOP DISCHARGE VALVE, DIAPHRAGMS P, O-RINGS T	FEP	9 19 624 59	9 24 625 59	9 38 626 59	9 57 627 59	9 76 628 59
4	4	BALL VALVES E	EPDM	4 15 032 72	1 15 032 72	1 25 032 72	1 40 032 72	1 50 032 72
		BALL VALVES T	PTFE	4 15 032 60	1 15 032 60	1 25 032 60	1 40 032 60	1 50 032 60
5	4	VALVE SEAT FOR BALL VALVE, LIQUID SECTION H+J	PE	2 10 018 52	2 15 018 52	2 25 018 52	2 40 018 52	2 50 018 52
		VALVE SEAT FOR BALL VALVE, LIQUID SECTION T+U	PTFE	2 10 018 60	2 15 018 60	2 25 018 60	2 40 018 60	2 50 018 60
6	2	LOCK BOLT, LIQUID SECTION H+J	PE	7 10 013 52	7 15 013 52	7 25 013 52	7 40 013 52	7 50 013 52
		LOCK BOLT, CODE LIQUID SECTION T+U	PTFE	7 10 013 60	7 15 013 60	7 25 013 60	7 40 013 60	7 50 013 60
7	4	BOLT VALVE STOP, LIQUID SECTION H+J	PE	7 08 014 52	2 08 014 52	2 10 014 52	2 15 014 52	2 15 014 52
		BOLT VALVE STOP, LIQUID SECTION T+U	PTFE	7 08 014 60	2 08 014 60	2 10 014 60	2 15 014 60	2 15 014 60
8	2	PLUG SIDE HOUSING, LIQUID SECTION H	PE	7 10 017 51	17 15 017 51	7 25 017 51	7 40 017 51	7 50 017 51
		PLUG SIDE HOUSING, LIQUID SECTION J	PE CONDUCTIVE	7 10 017 55	17 15 017 55	7 25 017 55	7 40 017 55	7 50 017 55
		PLUG SIDE HOUSING, LIQUID SECTION T	PTFE	7 10 017 60	17 15 017 60	7 25 017 60	7 40 017 60	7 50 017 60
		PLUG SIDE HOUSING, LIQUID SECTION U	PTFE CONDUCTIVE	7 10 017 65	17 15 017 65	7 25 017 65	7 40 017 65	7 50 017 65
9	2	O-RING, PLUG SIDE HOUSING, DIAPHRAGMS E, O-RINGS E	EPDM	9 20 602 72	9 25 610 72	9 40 613 72	9 62 634 72	9 79 353 72
		O-RING, PLUG SIDE HOUSING, DIAPHRAGMS P, O-RINGS V	FKM	9 20 602 75	9 25 610 75	9 40 613 75	9 62 634 75	9 79 353 75
		O-RING, PLUG SIDE HOUSING, DIAPHRAGMS P, O-RINGS T	FEP	9 20 602 59	9 25 610 59	9 40 613 59	9 62 634 59	9 79 353 59
10	4	SHOCK ABSORBERS	NR	17 10 422 85	1 15 322 85	17 15 322 85	17 40 322 85	17 40 322 85
11	1	MANIFOLD DISCHARGE SIDE, LIQUID SECTION H	PE	17 10 011 51	17 15 111 51	17 25 011 51	17 40 111 51	17 50 111 51
		MANIFOLD DISCHARGE SIDE, LIQUID SECTION J	PE CONDUCTIVE	17 10 011 55	17 15 111 55	17 25 011 55	17 40 111 55	17 50 111 55
		MANIFOLD DISCHARGE SIDE, LIQUID SECTION T	PTFE	17 10 011 60	17 15 111 60	17 25 011 60	17 40 111 60	17 50 111 60
		MANIFOLD DISCHARGE SIDE, LIQUID SECTION U	PTFE CONDUCTIVE	17 10 011 65	17 15 111 65	17 25 011 65	17 40 111 65	17 50 111 65
12	1	MANIFOLD SUCTION SIDE, LIQUID SECTION H	PE	17 10 012 51	17 15 112 51	17 25 012 51	17 40 112 51	17 50 112 51
		MANIFOLD SUCTION SIDE, LIQUID SECTION J	PE CONDUCTIVE	17 10 012 55	17 15 112 55	17 25 012 55	17 40 112 55	17 50 112 55
		MANIFOLD SUCTION SIDE, LIQUID SECTION T	PTFE	17 10 012 60	17 15 112 60	17 25 012 60	17 40 112 60	17 50 112 60
		MANIFOLD SUCTION SIDE, LIQUID SECTION U	PTFE CONDUCTIVE	17 10 012 65	17 15 112 65	17 25 012 65	17 40 112 65	17 50 112 65
13	4	O-RING MANIFOLD, DIAPHRAGMS E, O-RINGS E	EPDM	9 15 630 72	9 20 631 72	9 33 632 72	9 50 633 72	9 62 634 72
		O-RING MANIFOLD, DIAPHRAGMS P, O-RINGS V	FKM	9 15 630 75	9 20 631 75	9 33 632 75	9 50 633 75	9 62 634 75
		O-RING MANIFOLD, DIAPHRAGMS P, O-RINGS T	FEP	9 15 630 59	9 20 631 59	9 33 632 59	9 50 633 59	9 62 634 59
14	2	DIAPHRAGM, DIAPHRAGMS E	EPDM	1 10 031 72	1 15 031 72	1 25 031 72	1 40 031 72	1 50 031 72
		DIAPHRAGM, DIAPHRAGMS P	PTFE/EPDM	1 10 031 67	1 15 031 67	1 25 031 67	1 40 031 67	1 50 031 67
15	1	CENTER BLOCK, AIR SECTION H	PE	17 10 040 51	25 15 040 51	25 25 040 51	25 40 040 51	17 50 040 51
		CENTER BLOCK, AIR SECTION J	PE CONDUCTIVE	17 10 040 55	25 15 040 55	25 25 040 55	25 40 040 55	17 50 040 55
16	1	AIR CONTROL SYSTEM	PETP	2 08 001 84	2 15 001 84	2 15 001 84	2 40 001 84	2 50 201 84
17	1	AIR INLET	PETP	1 08 047 84	1 15 047 84	1 15 047 84	1 40 047 84	1 40 047 84
18	1	SHAFT	1.4301	-	2 15 030 22	2 25 030 22	2 40 030 22	2 50 030 22
19	2	SET SCREW SHAFT	1.4305	-	9 10 220 22	9 12 221 22	9 16 222 22	9 20 223 22
20	2	SHAFT PISON RING, CPL.	PTFE	-	1 15 041 64	1 25 041 64	1 40 041 64	1 50 041 64
21	1	MUFFLER, CPL.	PE	1 08 244 51	1 15 244 51	1 15 244 51	1 40 244 51	1 50 244 51
22	2	TENSION DISC	1.4301	7 10 008 22	7 15 008 22	7 25 008 22	7 40 008 22	7 50 008 22
23	4	HOUSING BOLT, CPL.	1.4305	17 10 020 22	17 15 020 22	17 25 020 22	17 40 020 22	17 50 020 22

# ELASTOMERS

## WETTED ELASTOMERS

### EPDM

is a general purpose elastomer with good resistance to many acids and bases.

### FKM

is an elastomer with good corrosion resistance to a wide variety of chemicals.

### PTFE (POLYTETRAFLUOROETHYLENE)

is a thermoplastic polymer that is inert to most chemicals.

## REPAIR KIT

Spare part kits include everything needed to replace worn O-rings, ball valves, diaphragms, shaft seals, muffler and air control system that are required for a single pump.

Nomenclature Guide / Models	D038	D050	D100	D150	D200
DXXX - 1 2 3 - 4 5 6 7 - 8 9 10	PART NUMBER				
DXXX - NHH - EEHE DXXX - NJJ - EEHE DXXX - NHT - EETE DXXX - NJU - EETE	SC10-EE	SC15-EE	SC25-EE	SC40-EE	SC50-EE
DXXX - NHH - PTHV DXXX - NJJ - PTHV DXXX - NHT - PTTV DXXX - NJU - PTTV	SC10-VT	SC15-VT	SC25-VT	SC40-VT	SC50-VT
DXXX - NHH - PTHT DXXX - NJJ - PTHT DXXX - NHT - PTTT DXXX - NJU - PTTT	SC10-VT-FP	SC15-VT-FP	SC25-VT-FP	SC40-VT-FP	SC50-VT-FP



Pump-housing PE-Conductive: **II 2GDc IIB T70°C**

Pump-housing PTFE-Conductive: **II 2GDc IIB T80°C**

Warning: The temperature marking refers to the maximum surface temperature depending not on the equipment itself, but mainly on operating conditions. In this case, the maximum surface temperature depends upon the temperature of the process fluids.

# WARRANTY AND REGISTRATION

**WARRANTY.** All All-Flo products shall be covered by the standard All-Flo Limited Warranty in effect at the time of shipment. This warranty (which may be modified by All-Flo at any time) provides:

MATERIALS SOLD ARE WARRANTED TO THE ORIGINAL USER AGAINST DEFECTS IN WORKMANSHIP OR MATERIALS UNDER NORMAL USE (RENTAL USE EXCLUDED) FOR FIVE YEARS AFTER PURCHASE DATE. ANY PUMP WHICH IS DETERMINED TO BE DEFECTIVE IN MATERIAL AND WORKMANSHIP AND RETURNED TO ALL-FLO, SHIPPING COSTS PREPAID, WILL BE REPAIRED OR REPLACED AT ALL-FLO'S OPTION. CUSTOMER SHALL NOTIFY ALL-FLO IN WRITING WITHIN 30 DAYS OF ANY CLAIMED DEFECTS. NO MATERIALS CAN BE RETURNED WITHOUT THE PRIOR CONSENT OF ALL-FLO, AND IF APPROVED SHALL BE RETURNED TO ALL-FLO FREIGHT PREPAID. ALL-FLO'S LIABILITY FOR ANY BREACH OF THIS WARRANTY SHALL BE LIMITED TO EITHER REPLACEMENT OF THE MATERIALS OR, AT ALL-FLO'S SOLE OPTION, THE REFUND OF THE PURCHASE PRICE. ALL-FLO SHALL NOT BE HELD LIABLE FOR ANY INCIDENTAL OR CONSEQUENTIAL DAMAGES CAUSED BY BREACH OF THIS WARRANTY. THIS EXCLUSION APPLIES WHETHER SUCH DAMAGES WERE SOUGHT BASED ON BREACH OF WARRANTY, BREACH OF CONTRACT, NEGLIGENCE, STRICT LIABILITY IN TORT, OR ANY OTHER LEGAL THEORY. FURTHER, ALL-FLO SHALL NOT BE LIABLE FOR LOSSES, DELAYS, LABOR COSTS, OR ANY OTHER COST OR EXPENSE DIRECTLY OR INDIRECTLY ARISING FROM THE USE OF MATERIALS. ALL-FLO'S LIABILITY IS EXPRESSLY LIMITED TO THE REPLACEMENT OR REPAIR OF DEFECTIVE GOODS, OR THE TOTAL VALUE OF SUCH GOODS. THIS WARRANTY IS IN LIEU OF ALL OTHER WARRANTIES, WHETHER EXPRESS, IMPLIED, OR ORAL INCLUDING THE IMPLIED WARRANTY OF MERCHANTABILITY, ANY IMPLIED WARRANTY OF FITNESS FOR A PARTICULAR PURPOSE, AND ANY IMPLIED WARRANTIES OTHERWISE ARISING FROM A COURSE OF DEALING OR TRADE. All-Flo will not, in ANY event, be liable for any loss of profit, interruption of business or any other special, consequential or incidental damages suffered or sustained by Customer. All-Flo's total maximum liability to the customer in respect of sale of materials or services rendered by All-Flo is limited to the total monies received by All-Flo from the customer for the particular materials described in Customer's order.

All-Flo does not warrant any part or component that it does not manufacture, but will assign to the original end-user purchaser of any warranty received by it from the manufacturer, to extent such pass through is permitted by the manufacturer.



## REGISTRATION FORM

Pump Model \_\_\_\_\_ Pump Serial Number \_\_\_\_\_

Company Name \_\_\_\_\_

Name \_\_\_\_\_ Email \_\_\_\_\_

Phone # \_\_\_\_\_ City \_\_\_\_\_ State \_\_\_\_\_ Zip \_\_\_\_\_

Qty of Pumps \_\_\_\_\_ Fluid Pumping \_\_\_\_\_

How did you hear about us? Existing All-Flo user,  
Web, Distributor, Magazine...

\_\_\_\_\_

**MAIL TO:** All-Flo | Attn: Product Registration  
22069 Van Buren Street, Grand Terrace, CA 92313-5651



Scan QR code and  
complete form  
on mobile phone  
or visit

[www.all-flo.com/registration-form.html](http://www.all-flo.com/registration-form.html)

# NOTES

Lined area for taking notes.





PSG

22069 Van Buren Street

Grand Terrace, CA 92313-5651 USA

P: +1 (440) 354-1700 F: +1 (440) 354-9466

[all-flo.com](http://all-flo.com)

All-Flo is committed to the pursuit of designing and manufacturing the highest quality product available to industry. Since the beginning in 1986, All-Flo engineers have used their extensive knowledge of today's engineered materials, advanced air system logic and manufacturing techniques to develop the superior group of lube-free, air-operated diaphragm pumps found in this catalog. Every pump is performance engineered and quality built to provide trouble-free service under the toughest conditions.



Where Innovation Flows