



ITT

Goulds Pumps

Goulds CV 3196 *i-FRAME*[™]

Non-Clog Process Pumps with
i-ALERT[™] Patented Intelligent Monitoring



Engineered for life



CV 3196 *i-FRAME* STi
(2 x 2–8)

The CV 3196 *i-FRAME* is designed specifically to provide superior performance for process services containing solids. Goulds concentric vortex casing with recessed open impeller provides non-clogging capability with minimal solids degradation. In addition, the CV 3196 *i-FRAME* can handle liquids entrained with air or gas.



CV 3196 *i-FRAME* MTi/LTi
(2 x–10, 3 x 3–10, 2 x 3–13, 3 x 4–13)
CV 3196 LTi (4 x 6–13)
CV 3196 XLTi (6 x 8–15)

Goulds CV 3196 *i-FRAME*[™]

Recessed Impeller Process Pumps Designed for *Non-Clog* Solids Handling

- ◆ Capacities to 2700 GPM (610 m³/h)
- ◆ Heads to 440 feet (134 m)
- ◆ Temperatures to 500°F (260°C)
- ◆ Pressures to 285 PSIG (1965 kPa)

Performance Features for Solids Handling Services

Extended Pump Life

- ◆ Concentric vortex casing for non-clog, minimum wear
- ◆ Recessed impeller for minimum solids degradation
- ◆ TaperBore[™]/BigBore[™] seal chambers
- ◆ *i-FRAME* power ends

Ease of Maintenance

- ◆ Back pull-out design
- ◆ Parts interchangeable with Goulds Model 3196 *i-FRAME*
- ◆ External impeller adjustment
- ◆ Easy retrofit

Safety

- ◆ ANSI B15.1 coupling guard
- ◆ Ductile iron frame adapter

Services

- ◆ Filter slurries
- ◆ Latex
- ◆ Polystyrene beads
- ◆ Crystal suspensions
- ◆ Screen rejects
- ◆ Hydropulper pump
- ◆ Sodium chlorate slurry
- ◆ Fruit and vegetable suspensions
- ◆ Dye liquor
- ◆ Fibrous wastewater
- ◆ Long fibre white water
- ◆ Primary cleaner pump

Goulds CV 3196 *i-FRAME*™ Designed for Solids Handling Services

Not All Pumps Are Designed to Handle Certain Bulky/Fibrous or Shear Sensitive Solids

Conventional end suction pumps have close clearances between impeller and casing to maintain efficiency and performance. However, when handling certain bulky, fibrous solids, they can clog. In addition, high velocities in the casing cause increased wear, and can degrade or shear pumpage.

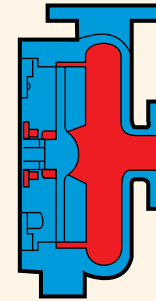
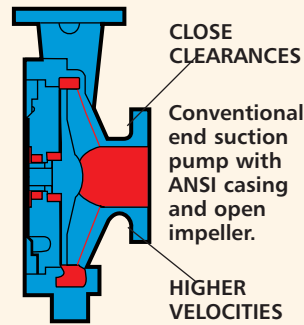

CV 3196 *i-FRAME* end suction pump with circular volute casing and recessed impeller designed to prevent clogging and degradation of solids.

CV 3196 *i-FRAME*™ Designed Specifically for Non-Clog Pumping with Minimum Solids Degradation

Since the induced flow or vortex impeller is recessed from the casing, velocities are low, and solids contact with the impeller is reduced, wear rate, solids degradation and shearing of liquid are minimized.

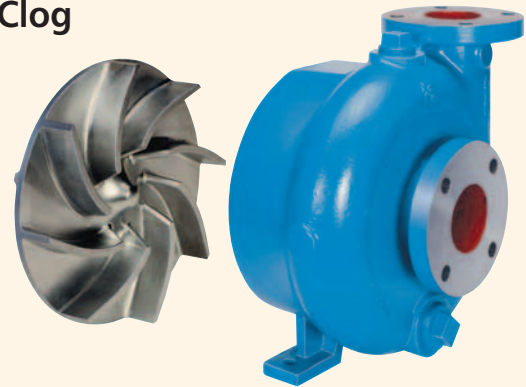

The casing design is well suited to handling solids in liquid suspension. Anything that can exit the discharge will pass through the pump.

Reduced Radial Loads Trouble-Free Operation At Low Flows

Many users throttle pumps to attain desired low flow performance. Because most pumps are not designed to operate continuously in this range, the resultant higher radial loads and increased shaft deflection lead to premature bearing and mechanical seal failure.

An added benefit of recessed impeller pumps is reliable operation at low flows. The CV 3196 *i-FRAME* uses a concentric casing which reduces radial loads by as much as 85% compared to end suction expanding volute pumps at low flows. Bearing, seal and overall pump life are optimized.

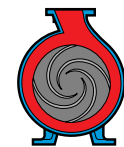
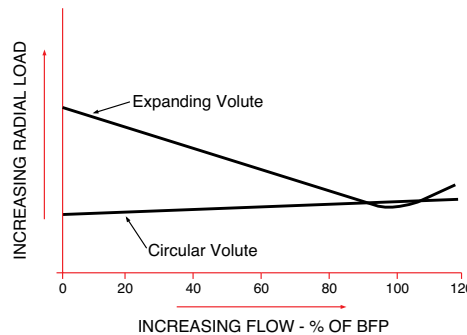

EXPANDING VOLUTE PUMP

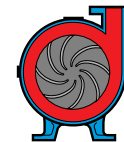

CV 3196 *i-FRAME* CIRCULAR VOLUTE PUMP

Easy Replacement or Retrofit

Pump Replacement

Since the CV 3196 *i-FRAME* foot mounting dimensions are the same as ANSI pumps, replacing ANSI pumps not designed to handle solids is simple... the inadequate pump is easily replaced by the appropriate size Model CV 3196 *i-FRAME*.

Pump Retrofit

The CV 3196 *i-FRAME* uses all Goulds Model 3196 parts except casing and impeller, making pump retrofit and upgrade easy and economical.

A CV 3196 *i-FRAME* retrofit kit (casing and impeller) easily converts an existing 3196.



Maximum Sealing Flexibility

To meet ANSI B73.1M specifications, Goolds provides the best choice of stuffing box or seal chamber and a wide range of sealing arrangements.

PACKED BOX

- Teflon*—Impregnated Fiber Packing
- Standard Bore Stuffing Box

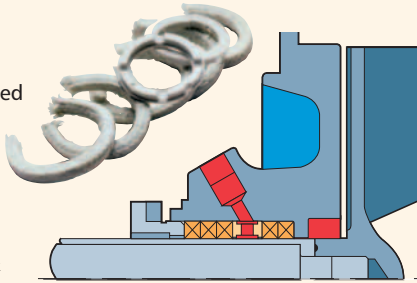

*E.I. DuPont reg. trademark

Your Goolds representative will gladly recommend the best sealing solution for your service...some of which are illustrated below.

SINGLE INSIDE SEAL

- Flexibly Mounted Seal with Throat Bushing
- BigBore[™] Seal Chamber (use TaperBore[™] if throat bushing not required).

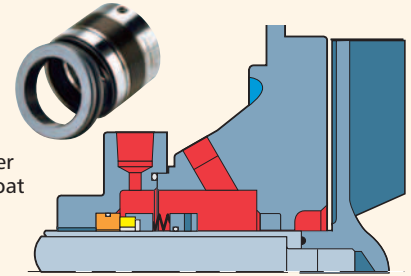

CONVENTIONAL DOUBLE SEAL

- BigBore[™] Seal Chamber

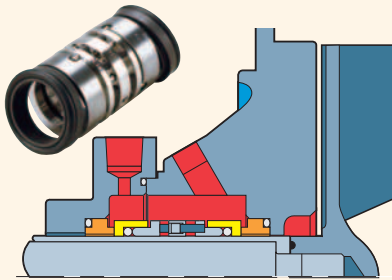

SINGLE CARTRIDGE SEAL

- TaperBore[™]PLUS Seal Chamber

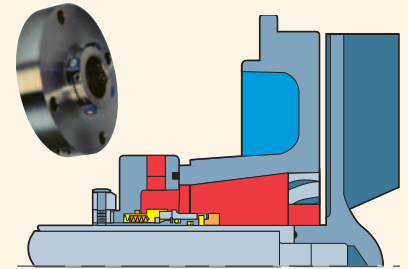

Goolds *i-FRAME*[™] Power Ends Designed for Reliability, Extended Pump Life

Patented *i-ALERT*[™] Condition Monitor

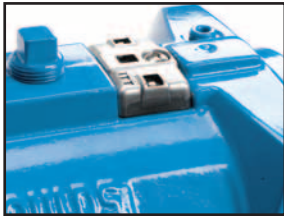

The heart of the *i-FRAME*, the *i-ALERT* condition monitor unit continuously measures vibration and temperature at the thrust bearing and automatically indicates when pre-set levels of vibration and temperature have been exceeded, so that changes to the process or machine can be made before failure occurs.

A visual indication of pump health makes walk-around inspections more efficient and accurate. The result is a more robust process to monitor and maintain all your ANSI pumps so that your plant profitability is maximized.

Shaft and Bearings Engineered for Maximum Reliability

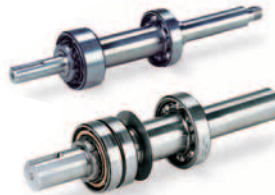

Fatigue life *more than double that* of conventional bearing steels.

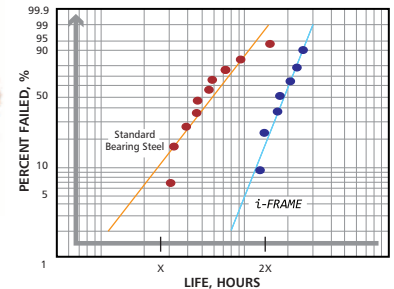

Inpro VBXX-D Hybrid Bearing Isolators

Most bearings fail before reaching their potential life. They fail for a variety of reasons, including contamination of the lubricant. INPRO VBXX-D has long been considered the industry standard in bearing lubricant protection. The *i-FRAME* now improves upon that design by offering stainless steel rotors, for maximum protection against contaminants and the corrosive effects of seal leakage or environmental conditions. These seals are non-contacting and do not wear.

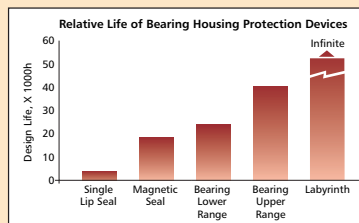

Optimized Oil Sump Design

Internal sump geometry is optimized for longer bearing life. Sump size increased by 10%-20% results in better heat transfer and cooler bearings. Contoured design directs contaminants away from bearings, to the magnetic drain plug for safe removal.

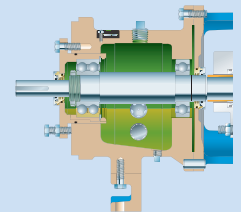

Larger Means Cooler
 GOOLDS
 Industry Average

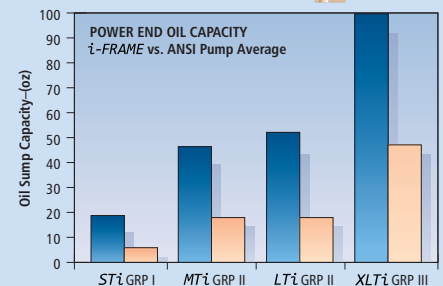



CV 3196 *i-FRAME*[™] Non Clog Process Pumps

Featuring *i-ALERT*[™]
Patented Monitoring

i-ALERT CONDITION MONITOR (Patent Pending)

Constantly measures vibration and temperature at the thrust bearing. Colored LED's indicate general pump health. Provides early warning of improper operation before catastrophic failure occurs.

INPRO VBXX-D HYBRID LABYRINTH SEALS

Prevents premature bearing failure caused by lubricant contamination or loss of oil. Stainless steel rotors for optimal performance in corrosive environments.

CONTINUOUS PERFORMANCE

Original flow, pressure and efficiency are maintained by simple external adjustment resulting in long-term energy and repair parts savings.

PREMIUM SEVERE-DUTY THRUST BEARINGS

Increase bearing fatigue life by 2-5X that of conventional bearing steels.

HEAVY DUTY SHAFT AND BEARINGS

Rigid shaft designed for minimum deflection at seal faces — less than 0.002 in. (.05 mm). Bearings sized for 10-year average life under tough operating conditions. Available with or without shaft sleeve.

OPTIMIZED OIL SUMP DESIGN

Increased oil capacity provides better heat transfer for reduced oil temperature. Bearings run cooler and last longer. Contaminants directed away from bearings to magnetic drain plug.

ONE – INCH BULL'S EYE SIGHT GLASS

Assures proper oil level critical to bearing life. Can be mounted on either side of pump for installation flexibility.

i-FRAME POWER END

Designed for reliability and extended pump life, backed with a 5-year warranty.

MAGNETIC DRAIN PLUG

Standard magnetic drain plug helps protect bearings and prolong life.

SEALING FLEXIBILITY

Wide range of sealing arrangements available to meet service conditions. Engineered seal chambers improve lubrication and heat removal (cooling) of seal faces for extended seal life and pump uptime.

DUCTILE IRON FRAME ADAPTER

Material strength equal to carbon steel for safety and reliability.

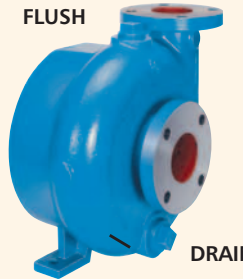

OPTIONAL FLUSH AND DRAIN CONNECTIONS

Provide capability to clean impeller and casing without disturbing piping. Scheduled maintenance is easy.

NON-CLOG CIRCULAR CASING

Large open passageways prevent clogging when handling bulky, stringy or fibrous liquids. Circular volute reduces radial loads during low flow operation.

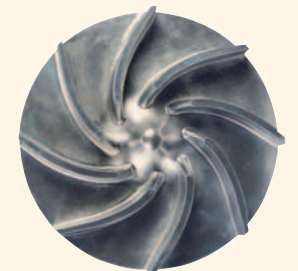

RECESSED IMPELLER

Since impeller is recessed from casing, velocities are low and solids contact with impeller is reduced. Wear rate, solids degradation and shearing of liquid are minimized. Liquids containing significant entrained air or gas can also be pumped.

SERRATED FLANGES

For positive sealing against leakage. Meets ANSI B16.5 requirements. Class 150 FF standard.

POSITIVE SEALING

Fully confined gasket at casing joint protects alignment fit from liquid, makes disassembly easier.

Sectional View

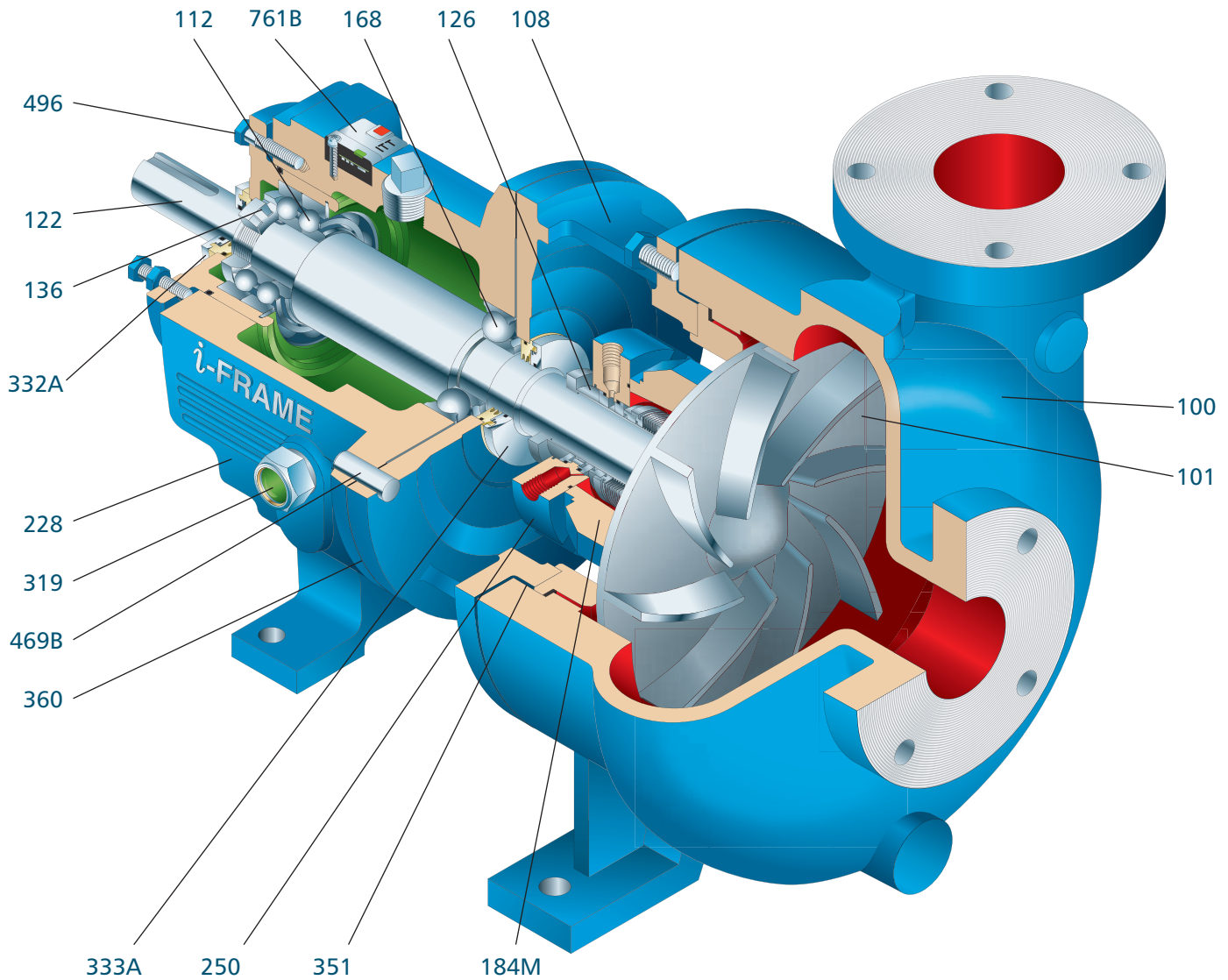

Bonus Interchangeability

i-FRAME™ Series Power Ends Fit 7 Different Process Pumps

Minimize inventory, reduce downtime.



3196
Process Pumps



CV 3196
Non-Clog
Process Pumps



HT 3196
High Temperature
Process Pumps



LF 3196
Low Flow ANSI
Process Pumps



3198
PFA TEFLON®-Lined
Process Pumps



3796
Self-Priming
Process Pumps



3996
In-Line Process
Pumps

Parts List and Materials of Construction

Item Number	Part Name	Material			
		Ductile Iron/ CD4MCuN Trim	CD4MCuN	Alloy 20	Hastelloy B & C
100	Casing	Ductile Iron	CD4MCuN	Alloy 20	Hastelloy
101	Impeller	CD4MCuN	CD4MCuN	Alloy 20	Hastelloy
105	Lantern Ring (Not Illustrated)	Glass-Filled Teflon*			
106	Stuffing Box Packing (Not Illustrated)	Teflon* Impregnated Fibers			
108	Frame Adapter	Ductile Iron			
112	Thrust Bearing	Double Row Angular Contact Conrad**			
122	Shaft—Less Sleeve (Optional)	SAE4140	316SS	Alloy 20	Hastelloy
122	Shaft—With Sleeve	SAE4140			316SS
126	Shaft Sleeve	316SS	Alloy 20		Hastelloy
136	Bearing Locknut and Lockwasher	Steel			
168	Radial Bearing	Single Row Deep Groove			
184	Stuffing Box Cover (Packed Box)	Ductile Iron	CD4MCuN	Alloy 20	Hastelloy
184M	Seal Chamber (Mechanical Seal)	Ductile Iron	CD4MCuN	Alloy 20	Hastelloy
228	Bearing Frame	Cast Iron (Ductile Iron for STX Group)			
250	Gland	316SS	CD4MCuN	Alloy 20	Hastelloy
262	Repeller/Sleeve (Dynamic Seal Option)	CD4MCuN		Alloy 20	Hastelloy
264	Gasket, Cover-to-Backplate (Dynamic Seal)	Teflon*			
265A	Stud/Nut, Cover-to-Adapter	304SS			
319	Oil Sight Glass	Glass/Steel			
332A	INPRO® Labyrinth Oil Seal (Outboard)	Stainless Steel / Bronze			
333A	INPRO® Labyrinth Oil Seal (Inboard)	Stainless Steel / Bronze			
351	Casing Gasket	Aramid Fiber with EPDM Rubber			
358A	Casing Drain Plug (Optional)	Steel	Alloy 20	Alloy 20	Hastelloy
360	Gasket, Frame-to-Adapter	Buna			
370	Cap Screw, Adapter-to-Casing	Steel	304SS		
412A	O-ring, Impeller	Glass-Filled Teflon*			
418	Jacking Bolt	304SS			
444	Backplate (Dynamic Seal Option)	Ductile Iron	CD4MCuN	Alloy 20	Hastelloy
469B	Dowel Pin	Steel			
496	O-ring, Bearing Housing	Buna Rubber			
761B	i-ALERT Condition Monitor	Stainless Steel / Epoxy			

*E.I. DuPont Reg. Trademark **LTX Power End features Duplex Angular Contact

Construction Details All dimensions in inches and (mm).

		STi	MTi	LTi	XLTi
Shaft	Diameter at Impeller	.75 (19)	1 (25)	1.25 (32)	1.5 (38)
	Diameter in Stuffing Box/Seal Chamber (Less Sleeve) (With Sleeve)	1.375 (35)	1.75 (45)	2.125 (54)	2.5 (64)
		1.125 (29)	1.5 (38)	1.875 (48)	2 (51)
	Diameter Between Bearings	1.5 (38)	2.125 (54)	2.5 (64)	3.125 (79)
	Diameter at Coupling	.875 (22)	1.125 (29)	1.875 (48)	2.375 (60)
	Overhang	6.125 (156)	8.375 (213)	8.375 (213)	9.969 (253)
	Maximum Shaft Deflection	0.002 (0.05)			
Sleeve	O.D. thru Stuffing Box/Seal Chamber	1.375 (35)	1.75 (45)	2.125 (54)	2.5 (64)
Bearings	Radial	6207	6309	6311	6313
	Thrust	5306 A/C3	5309 A/C3	7310 BECBM	5313 A/C3
	Bearing Span	4.125 (105)	6.75 (171)	6.875 (164)	9.25 (235)
BigBore™ Seal Chamber	Bore	2.875 (73)	3.5 (89)	3.875 (98)	4.75 (121)
Stuffing Box	Bore	2 (51)	2.5 (64)	2.875 (73)	3.375 (86)
Power Limits	HP (kW) per 100 RPM	1.1 (.82)	3.4 (2.6)	6.6 (4.9)	14.0 (10.5)
Maximum Liquid Temperature	Oil/Grease Lubrication without Cooling	350° F (177° C)			
	Oil Lubrication with Finned Cooler	500° F (260° C)			
Casing	Corrosion Allowance	.125 (3)			

Hydraulic Coverage

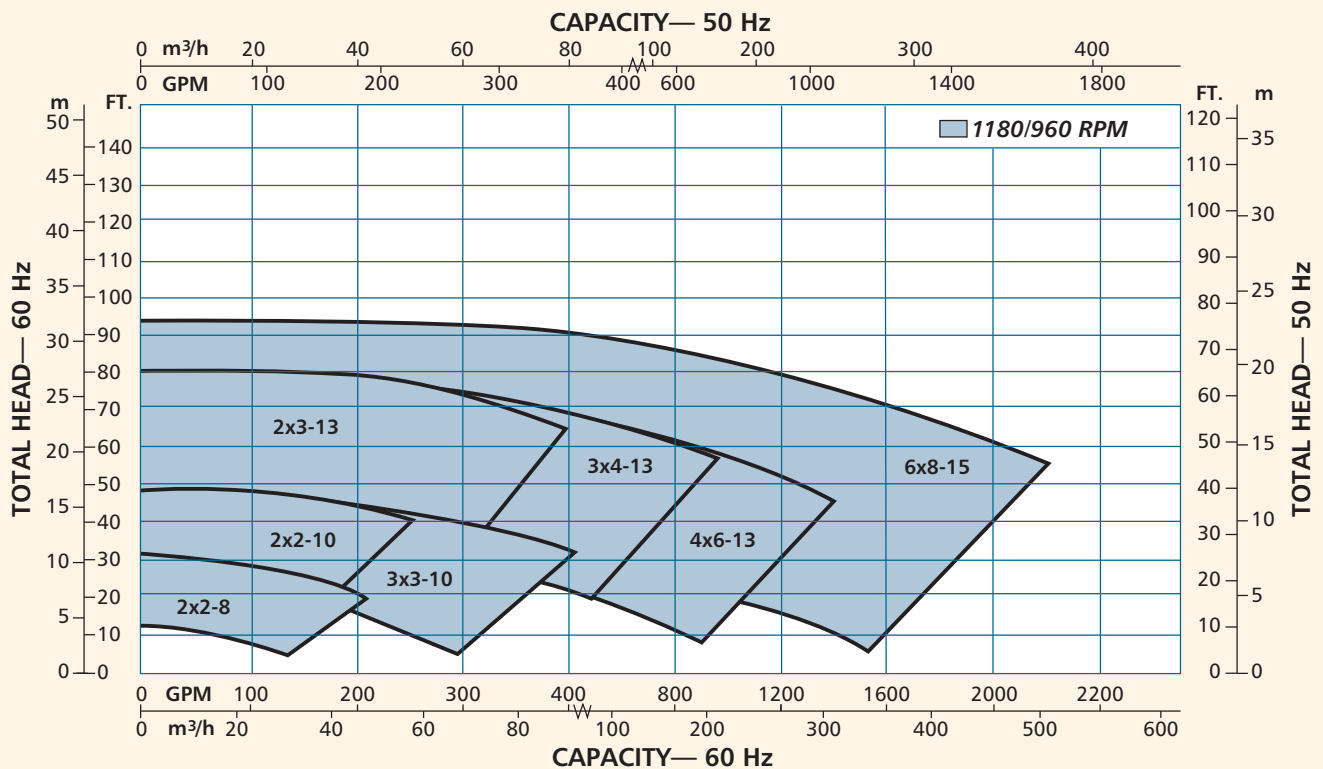
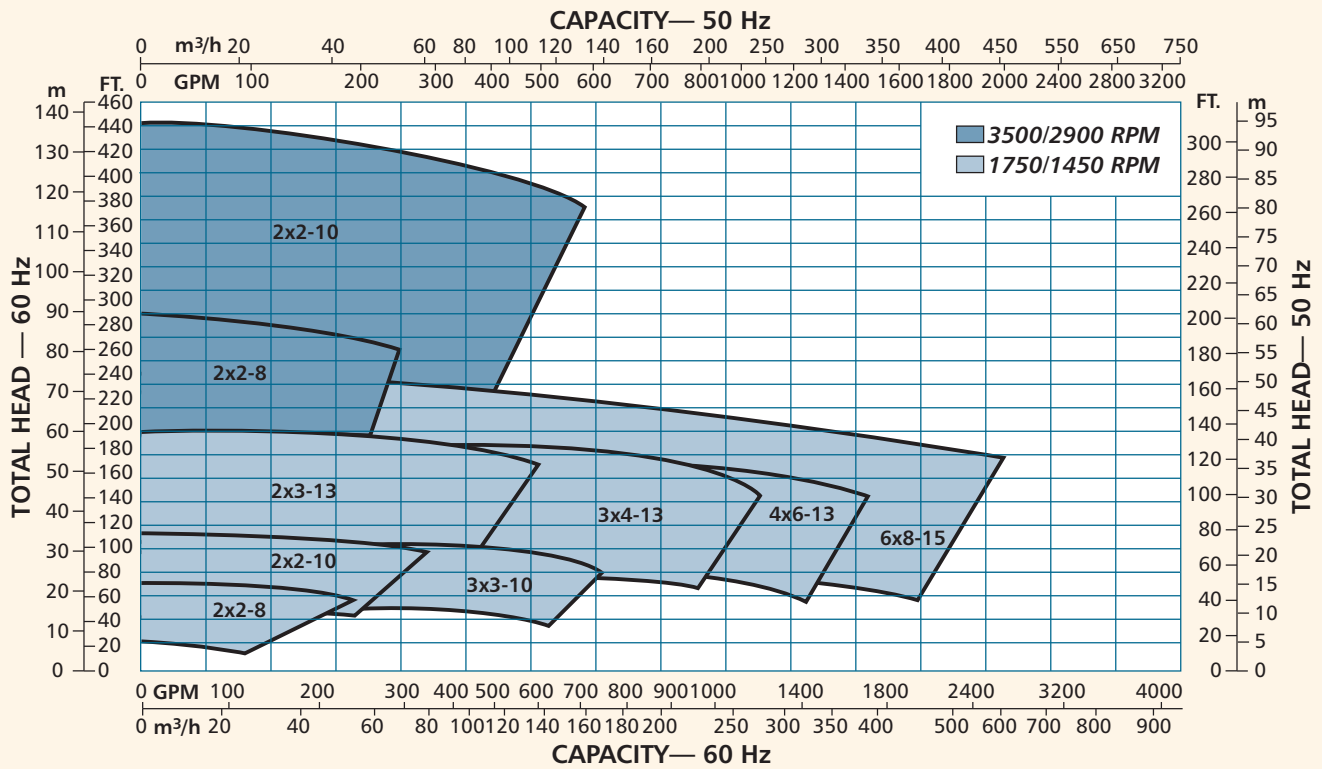

Dimensions CV 3196i-FRAME™

All dimensions in inches and (mm). Not to be used for construction.

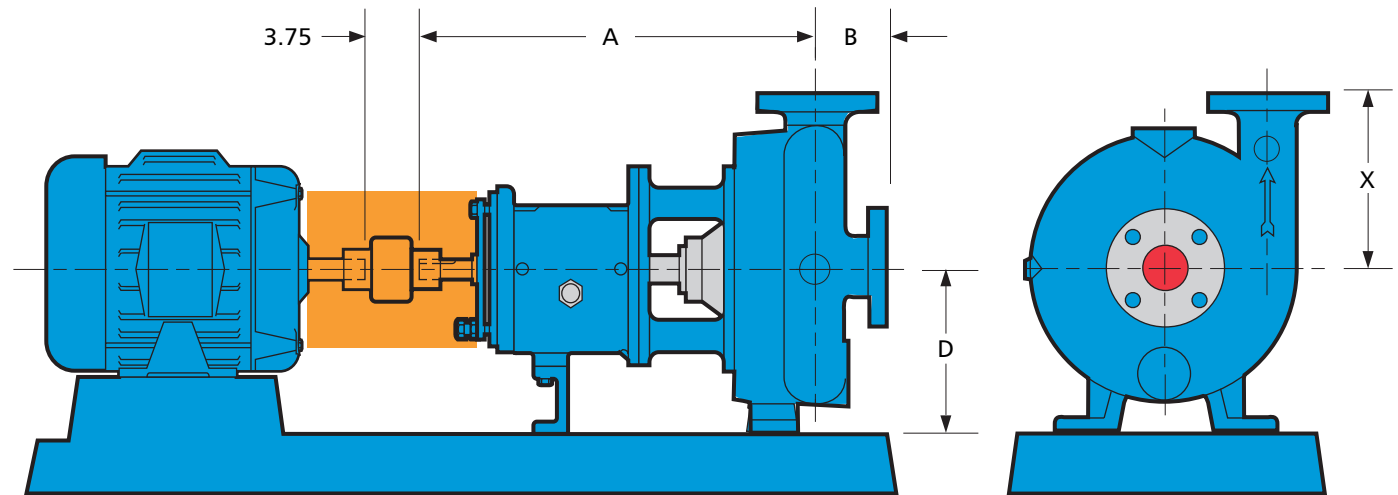

DIMENSIONS						
Group	Size	A	B	D	X	Bare Pump Weight Lbs. (kg)
STi	2x2-8	15.38 (391)	2.75 (70)	5.25 (133)	6.50 (165)	140 (65)
MTi/ LTi	2x2-10	21.75 (552)	3.50 (89)	8.25 (210)	8.50 (216)	260 (120)
	3x3-10	22.50 (572)	4.25 (108)	8.25 (210)	9.00 (229)	280 (125)
	2x3-13	22.38 (568)	4.12 (105)	10.00 (254)	10.50 (267)	360 (165)
	3x4-13	22.81 (579)	4.12 (105)	10.00 (254)	10.50 (267)	410 (185)
LTi	4x6-13	23.13 (588)	4.75 (121)	10.00 (254)	11.50 (292)	430 (194)
XLTi	6x8-15	32.5 (826)	6.5 (165)	14.5 (368)	14.00 (356)	486 (219)

Baseplate Mounting Options

Goulds offers a complete range of mounting systems to meet plant reliability requirements, and to make alignment and maintenance easier.

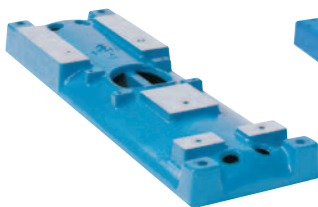

CAMBER TOP CAST IRON
Rigid and corrosion resistant, it is preferred by many plants.

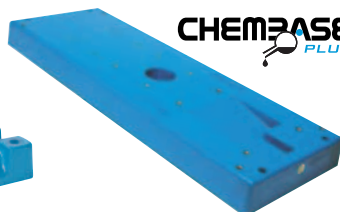
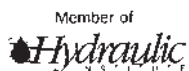

CHEMBASE PLUS™
Polymer concrete construction provides exceptional rigidity & corrosion resistance. ANSI 1991 dimensional.



FABRICATED STEEL
Economical baseplate that meets ANSI/ASME B73.1 M current edition dimensional requirements.

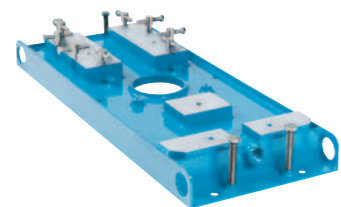

ENHANCED FEATURE FABRICATED STEEL
Upgraded ANSI baseplate designed to maximize pump operation life and ease installation by meeting API-minded chemical pump users toughest requirements.



PRO Services®
Extending
Equipment Life...

Product Repair (all types and brands of rotating equipment)

- Service Center Repair
- Field Service
- Parts Supply

Reliability Improvement

- Inventory Management
- Replacement/Exchange
- Turnkey Repair/Installation
- Training

Optimization of Assets

- Predictive Analysis/Condition Monitoring
- Root Cause Failure Analysis
- Pump & System Assessments
- Upgrades – Mechanical & Hydraulic
- Maintenance Management/Contract Maintenance

-
- Technical Expertise
 - Fast Turnaround
 - Factory Trained Service Personnel
 - Emergency Service – 24 hours/day, 7 days/week
 - Quality
 - ISO and Safety Certified

PROSMART

ProSmart® provides continuous machinery monitoring to identify little problems before they become big problems...like downtime. Using wireless technology, advanced signal processing capabilities, and easy-to-deploy sensors, ProSmart offers an affordable means to monitor all of your rotating equipment anywhere in the world. By identifying and alerting you to changes in operating conditions, ProSmart increases your time to respond to either correcting the upset condition, or properly plan its repair.



Key Features include:

- Continuous data acquisition and analysis – ProSmart collects vibration, temperature, and available process conditions every five seconds; saving you time from routine data collection.
- Automatic Notification and Accessibility – By alerting when a machine goes into distress, you are able to focus your resources on recovery activities. The ProNet web-hosted solution allows access to information anywhere in the world through a standard Internet browser connection.
- Advanced diagnostic tools – More than simple overall data, ProSmart provides advanced analysis capabilities such as time-waveform, spectral, and spectral windowing.
- Easy to deploy – Using plug and play sensors, wireless connectivity, and an industrially hardened enclosure, ProSmart can be easily deployed throughout your plant, including hazardous areas.

PUMPSMART

PumpSmart® is the latest advancement in pump control and protection to reduce energy consumption, increase uptime and decrease maintenance cost. It allows the pump to be right-sized to the application by dialing in the speed and torque which increases flow economy, reduces heat and vibration, and improves overall system reliability.

- **Simplified Pump Control** — PumpSmart was designed specifically to optimize pumping applications and can be used to control a single pump or coordinate between multiple pumps without the need for an external controller.
- **Pump Protection** — PumpSmart guarantees to protect the pump from upset conditions with patented sensorless pump protection algorithms.
- **Smart Flow** — PumpSmart features a sensorless flow function for centrifugal pumps that can calculate the flow of the pump within ± 5% of the pump rated flow.
- **Drive for the DCS** — While most VFDs can only provide basic information, PumpSmart offers unparalleled insight to the pump operation which allows for smoother process control and efficiency.
- **Pump Experts** — PumpSmart is a variable speed drive with pump-specific algorithms imbedded into the drive. With over 150 years of pump knowledge, let the pump experts take responsibility of your pump system.



Visit our Web site at www.gouldspumps.com

