



Vertical Turbine Pumps



ITT

ENGINEERED FOR LIFE

Models VIT, VIC and VIS

Flexibility by Design:

Three Pump Models, One Common Bowl Assembly

The three different pump models in the vertical turbine line have one thing in common – the hydraulic design of the pump bowl assembly. Using state-of-the-art techniques in turbine pump design, Goulds vertical turbine line covers a wide range of hydraulic conditions to meet virtually every pumping service in the industry with optimum efficiency.

This bulletin is designed to assist the user in selecting the best pump for the conditions required; however, any questions will be answered promptly by calling the Goulds sales office or representative in your area.

Goulds flexibility of design allows the use of a wide range of materials and design features to meet the custom requirements of the user. No matter what the requirements, Goulds can design and manufacture the pump to best satisfy them, specifically and thoroughly.

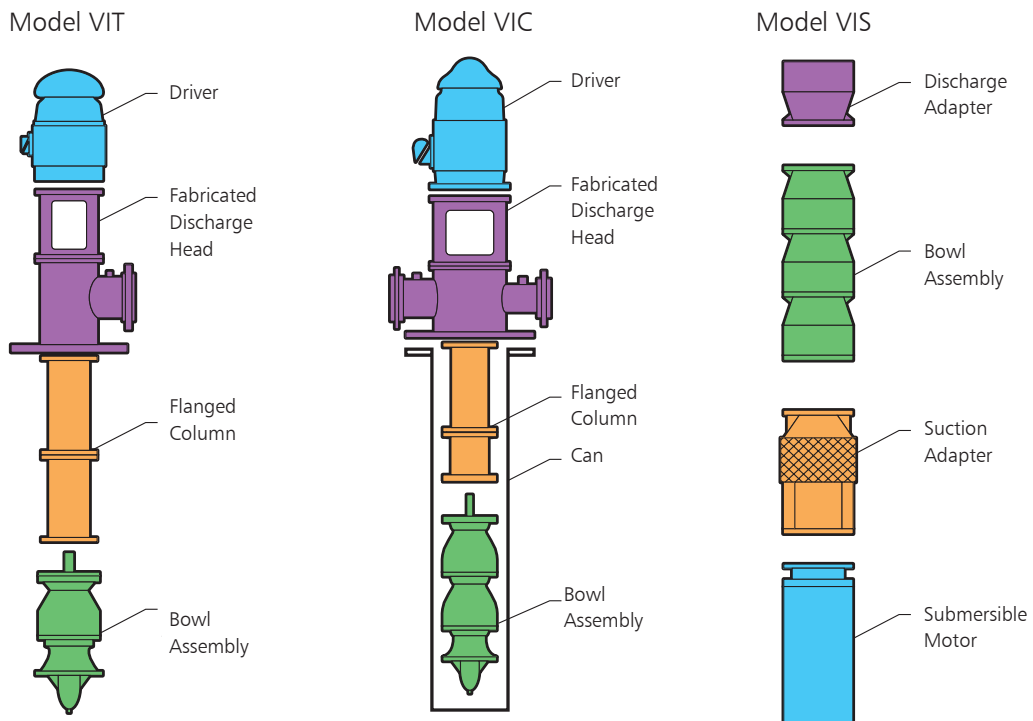

Goulds Vertical Turbine Pumps

Pump Bowl Assembly

The bowl assembly is the heart of the vertical turbine pump. The impeller and diffuser type casing are designed to deliver the head and capacity that your system requires in the most efficient way possible. The fact that the vertical turbine pump can be multi-staged allows maximum flexibility both in the initial pump selection and in the event that future system modifications require a change in the pump rating.

A variety of material options allows the selection of a pump best suited for even the most severe services. The many bowl assembly options available ensure that the vertical turbine pump satisfies the users' needs for safe, efficient, reliable and maintenance-free operation.

Standard Design Features

- **Suction Bell** - Allows smooth entry of liquid into first stage impeller eye, minimizes foundation opening.
- **Suction Bell Bearing** - Provided for shaft stability.
- **Sand Collar** - Prevents solids from entering suction bearing.
- **Impeller** - Semi-open or enclosed for appropriate service.
- **Pump Shaft** - Heavy duty 416SS standard, other alloys available for strength and corrosion resistance.
- **Flanged Bowls** - Registered fits ensure positive alignment, ease of maintenance.
- **Diffuser Bowl** - Available in variety of cast materials.
- **Sleeve Type Bearing** - Provided at each stage to assure stable operation.
- **Keyed Impellers** - Standard for API applications, 18" and larger sizes; furnished on all pumps for temperatures above 180° F (82° C) and on cryogenic services. Regardless of size, keyed impellers provide ease of maintenance and positive locking under fluctuating load and temperature conditions.

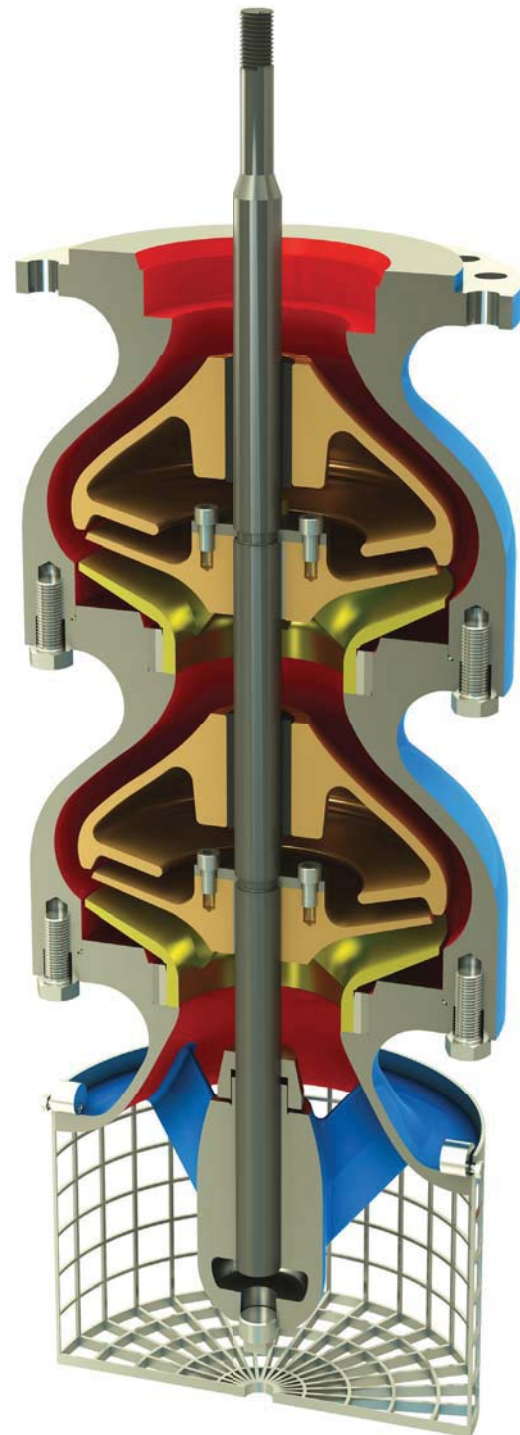

Pump Bowl Assembly Options

Choice of Semi-Open or Enclosed Impellers

Available in alloy construction for a wide range of corrosive/abrasive services.

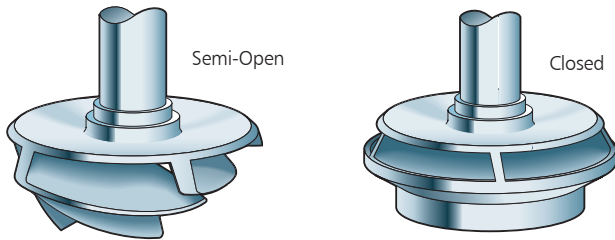

Strainers/Vortex Suppressor

Basket strainers are available to provide protection from large solids.



First Stage-Low NPSH X Impeller or Double Suction

For low NPSH_A applications, either large eye or double suction first stage available to minimize pump length.



Hydraulic Balanced Impeller

Optional dynamic balance to ISO Grade 1.0 (4 w/n)



Dual Wear Rings

Available for enclosed impellers and bowls; permits re-establishing initial running clearances and efficiency at lower cost. Hard facing of wear rings can be flushed when solids are present in pumpage.

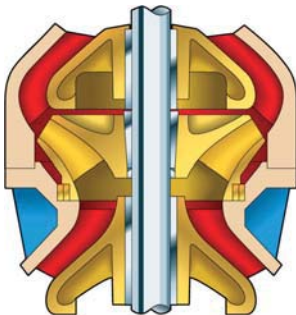

Hardfacing & Rifle Drilled Shaft

Hardfacing the surface of bearing and/or shaft to protect against wear from abrasives in the bearing area. Rifle drilling of bowl shafts available for bearing protection on abrasive services. Discharge bowl included with enclosed lineshaft construction.

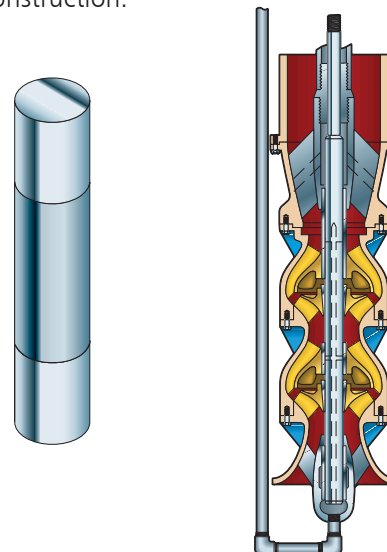

Flanged Column

Column sections are provided with flanged ends incorporating registered fits for ease of alignment during assembly to ensure concentricity. Our standard bearing retainers are welded into the column section.

Open Lineshaft Bearing

Flanged column / product lubricated lineshaft is recommended for ease of maintenance. Renewable shaft sleeve or hard facing of shaft available for longer life.

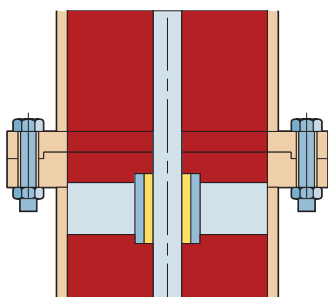

Enclosed Lineshaft

The lineshaft is protected by water flushing the enclosing tube bearing on corrosive / abrasive services. Oil lubricated lineshaft available on long settings.

Alignment is attained by register fit between the flange faces.

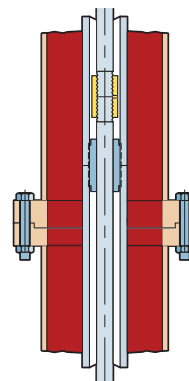

Threaded Lineshaft Coupling

Threaded lineshaft coupling is commonly used for lower horsepower pumps. It is more economical.

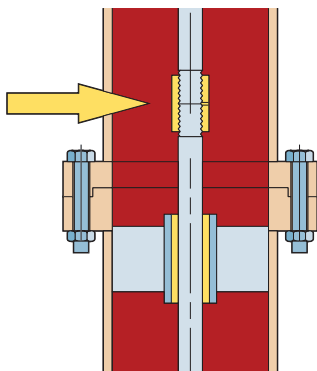

Keyed Lineshaft

Keyed lineshaft coupling is recommended for motors larger than 700 HP. It provides ease of maintenance.



Discharge Heads

Discharge Heads

The discharge head functions to change the direction of flow from vertical to horizontal and to couple the pump to the system piping in addition to supporting and aligning the driver. Discharge head accommodates all types of driver configurations. Optional sub-base can be supplied. Goulds offers three basic types for maximum flexibility.

VIT DISCHARGE HEAD

Suitable for all service conditions such as high or low temperature or corrosive services. Various materials available. Segmented elbow available for efficiency improvement. Access ports for easy access to seals and couplings. Base flange can be machined to match ANSI tank flange.



VIC DISCHARGE HEAD

VIC can also be supplied with the pump suction in the can.



BELOW GROUND DISCHARGE HEAD

Use whenever VIT pump is required to adapt to an underground discharge system.

- Finite Element Analysis is typically recommended on this configuration to evaluate the pump's dynamic behavior and capability to withstand the loads
- Robust design as a result of the cantilever load distribution applied to the foundation and anchor bolts
- Customized design to minimize the foundation opening



FAN AIR COOLED THRUST POT

- Cast steel body meeting API standard
- 25,000-hour L10 bearing life
- Two or three bearing configurations
- Momentary up-thrust capability
- Inpro seals - prevent oil contamination
- Vibration and temperature monitoring are standard provisions
- Oil lubricated thrust bearings & permanently-lubricated radial bearings

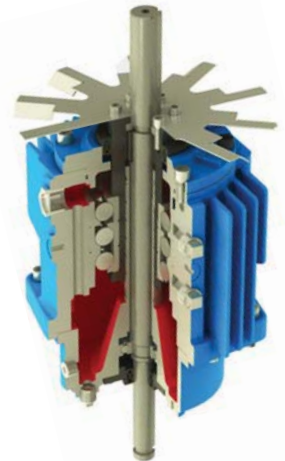

Seals & Couplings

Packed Box With or Without Sleeve Open Lineshaft

Whenever packing lubrication leakage can be tolerated and the discharge pressure does not exceed 150 psi, a packed box may be used. Optional headshaft sleeve or shaft hardfacing available to protect shaft.

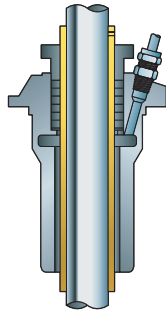

Single Seal

Most popular method — used for low to medium pressures. Cartridge style for ease of installation and maintenance.

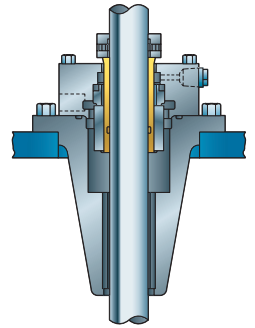

Water Flush or Oil Lubricated Enclosed Lineshaft

Water flush tube connection is supplied when pressurized water is introduced into the enclosing tube for bearing protection on abrasive services.

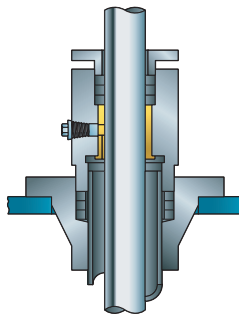

Dual Seals

Two seals mounted in-line. Chamber between seals can be filled with a buffer liquid and may be fitted with a pressure sensitive annunciating device for safety.

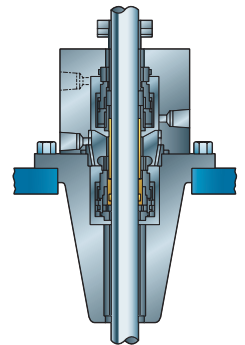

Adjustable Coupling (Type A)

For vertical solid shaft driver, impeller adjustment made by using adjustable plate in the coupling.

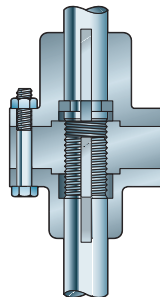

Adjustable Spacer Coupling (Type AS)

Same function as Type A coupling with addition of spacer. Spacer may be removed for mechanical seal maintenance without removing the driver.

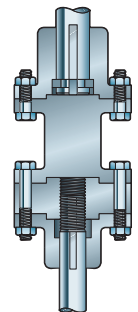

Model VIT

Vertical Industrial Turbine Pump

For higher flows refer to high capacity section

- Flows to 70,000 GPM (15,900 m³/Hr)
- Heads to 3,500 feet (1,060 m)
- Pressures to 2,500 psi (76kg/cm²)
- Bowl sizes from 6" to 55" (152.4 mm to 1,400 mm)
- Temperatures to 500° F (260° C)
- Horsepower to 5,000 HP (3,730 KW)

Design Advantages

- Fabricated discharge head and flanged column
- Flanged bowl construction
- 416SS shafting
- Alloy construction with external flush of critical wear areas available for corrosive/abrasive services
- Built-in alignment and simple piping for less costly installation and ease of maintenance / reduced downtime

Typical Services

- Cooling Water
- Seawater and River Water Intake
- Industrial Process Pumps
- Utility Circulating Water
- Condenser Circulating Water Pumps
- Fire Service
- Reclaimed Water



Cross Sectional

VIT (Product Lube)

TYPICAL MARKETS SERVED

- Power Generation
- Oil & Gas
- Mining
- Municipal
- General Industry
- Chemical

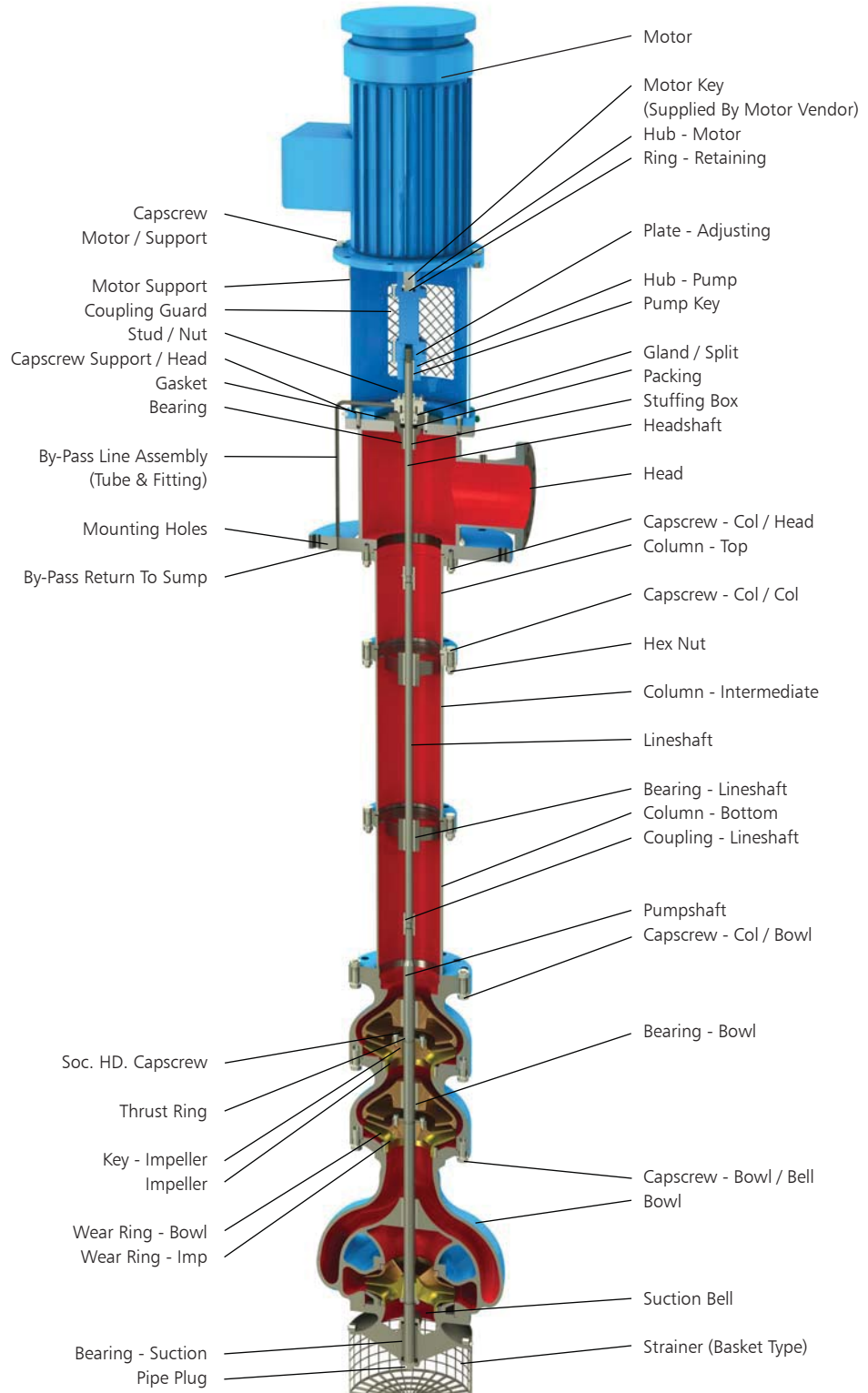

Cross Sectional

VIT (Enclosed Lineshaft)

TYPICAL MARKETS SERVED

- Mining
- Oil & Gas
- Municipal
- Power Generation
- General Industry
- Chemical

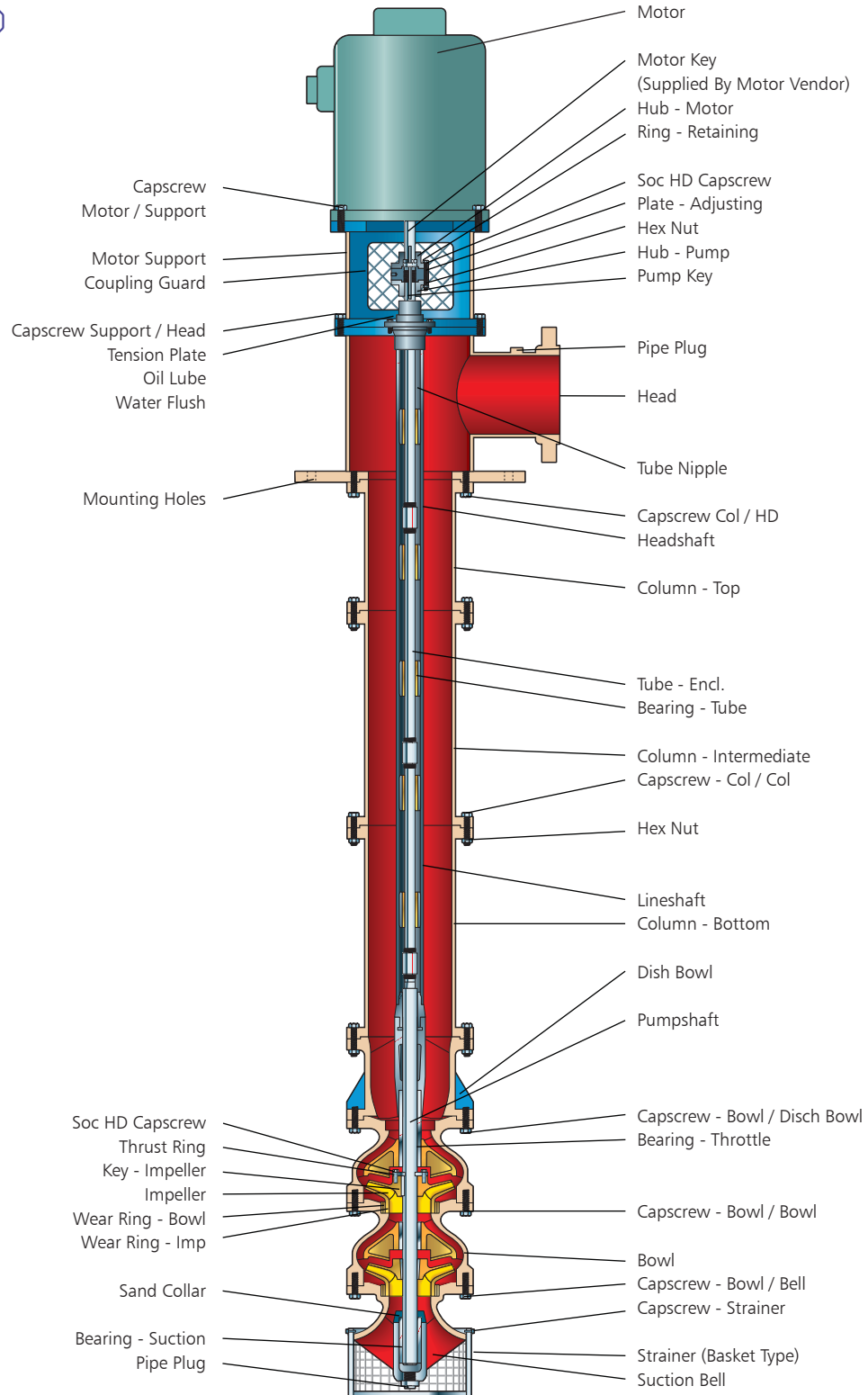

Model VIC

Vertical Industrial Can-Type Pump

- Flows to 70,000 GPM (15,900 m³/Hr)
- Heads to 3,500 feet (1,060 m)
- Pressures to 2,500 psi (76kg/cm²)
- Bowl sizes from 6" to 55" (152.4 mm to 1,400 mm)
- Temperatures to 500° F (260° C)
- Horsepower to 5,000 HP (3,730 KW)

Design Advantages

- Fabricated discharge head and flanged column
- Flanged bowl construction
- 416SS shafting
- In-Line suction and discharge simplifies installation
- Optional suction in can for site piping flexibility
- Inherent design features on Model VIC allow efficient operation at any NPSH available
- Alloy construction for corrosive / abrasive services

Typical Services

- Pipeline Booster
- Product Transfer, Refinery Blending
- Injection Secondary Recovery
- Chemical Transfer
- Boiler Feed
- Condensate
- Cryogenics
- LNG Transfer
- Light Hydrocarbons
- Water Services



Cross Sectional

VIC

TYPICAL MARKETS SERVED

- Power Generation
- Chemical
- Mining
- General Industry

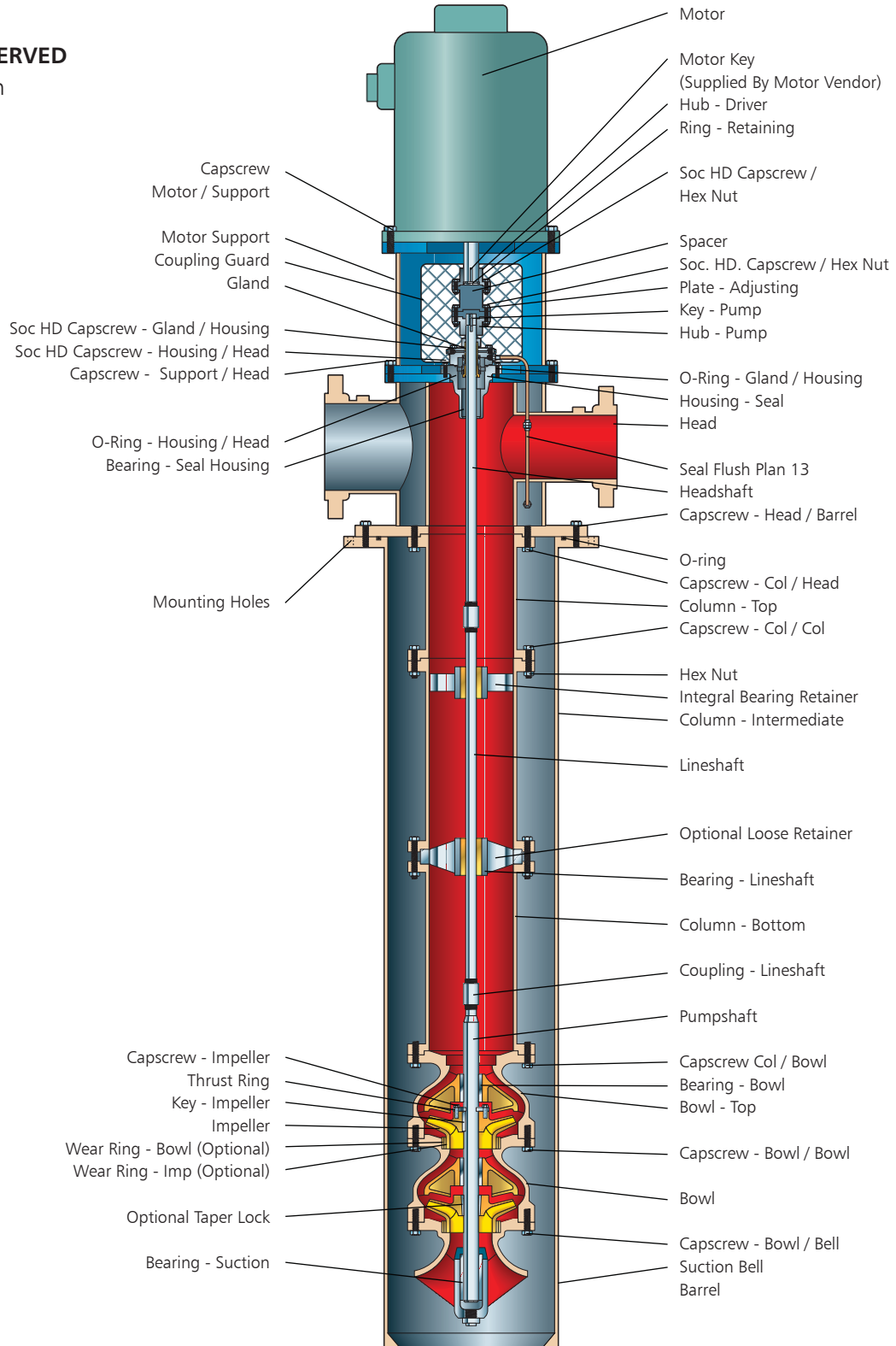

Cross Sectional

VIT (Per API-610)

TYPICAL MARKETS SERVED

- Oil & Gas
- Chemicals
- Pipeline Transfer
- Mining

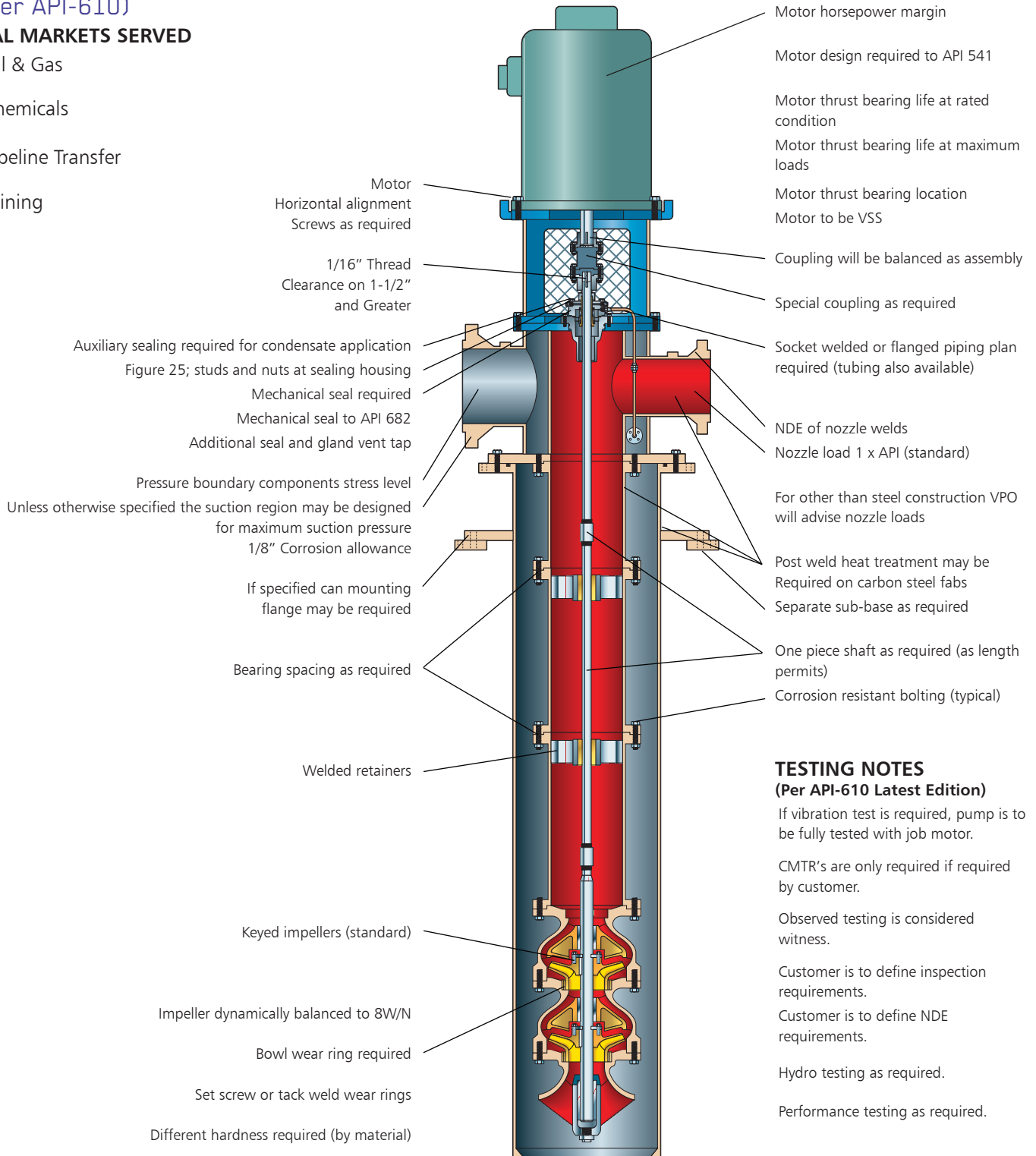

TESTING NOTES (Per API-610 Latest Edition)

If vibration test is required, pump is to be fully tested with job motor.

CMTR's are only required if required by customer.

Observed testing is considered witness.

Customer is to define inspection requirements.

Customer is to define NDE requirements.

Hydro testing as required.

Performance testing as required.

Model VIS

Vertical Industrial Turbine Pump

- Flows to 70,000 GPM (15,900 m³/Hr)
- Heads to 3,500 feet (1,060 m)
- Pressures to 2500 psi (76kg/cm²)
- Bowl sizes from 6" to 55" (152.4 mm to 1,400 mm)

Design Advantages

- Ideal for deep set applications where use of lineshaft pumps is impractical
- Complete unit is installed underground, resulting in quiet operation and space saving
- Long life / low maintenance – no lubrication, alignment

Services

- Irrigation
- Service Water
- Deep Well
- Sea Water Lift



Cross Sectional

VIS

TYPICAL MARKETS SERVED

- General Industry
- Oil & Gas

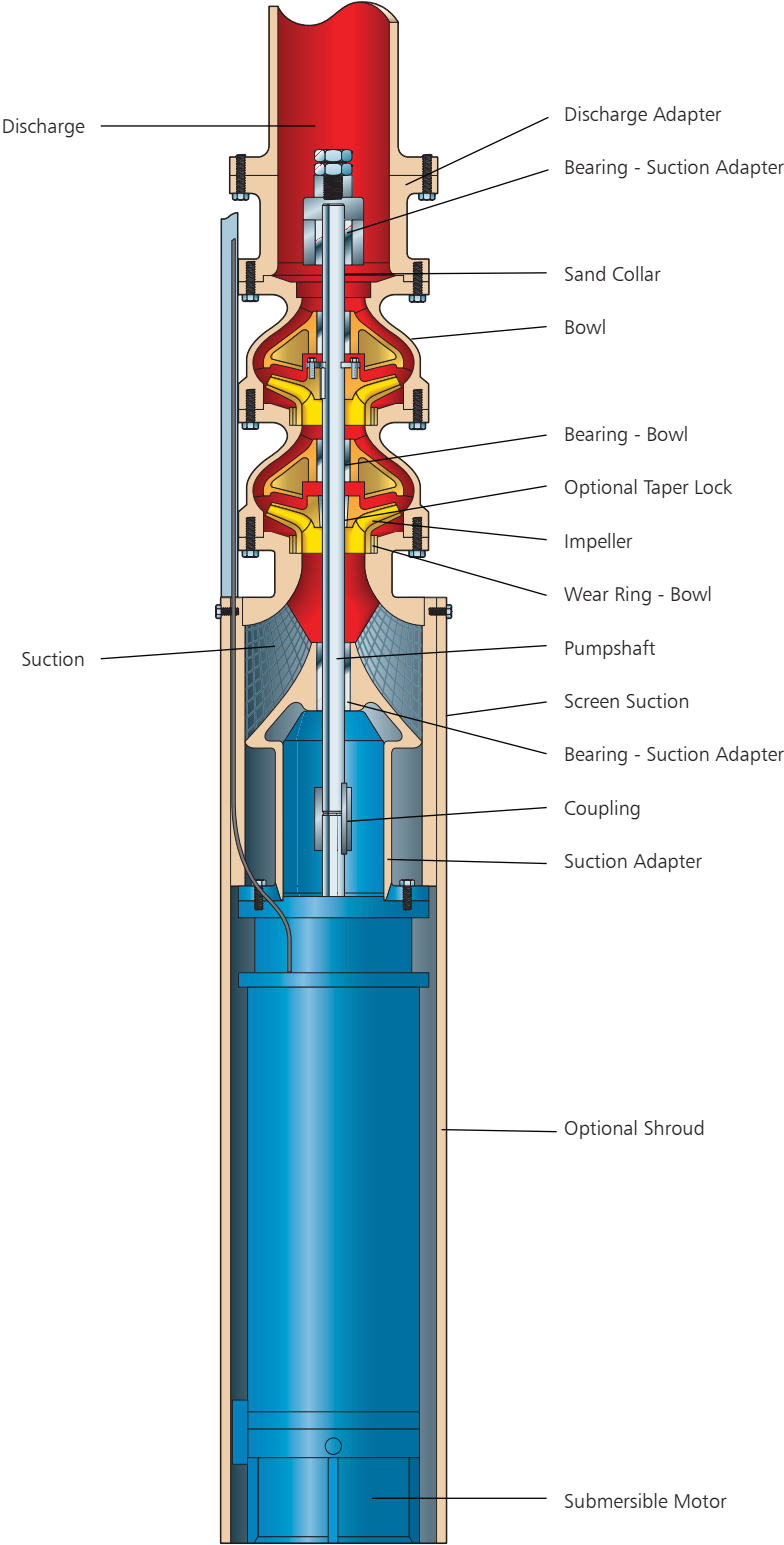

Hydraulic Coverage

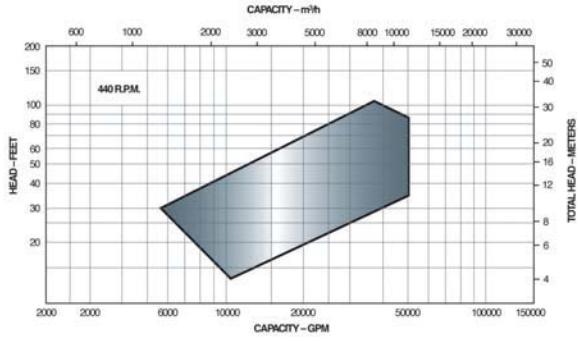
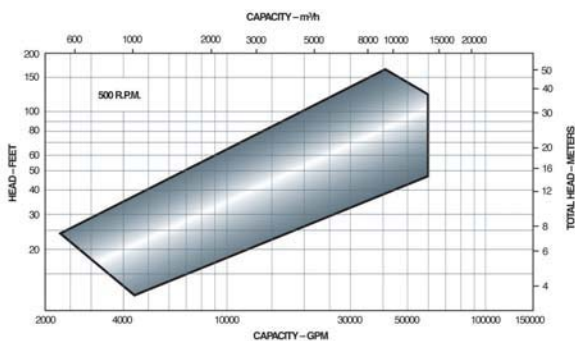
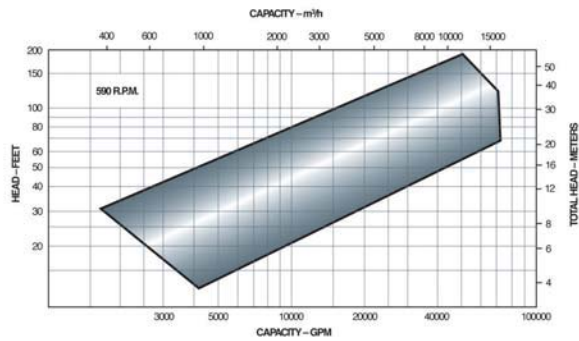
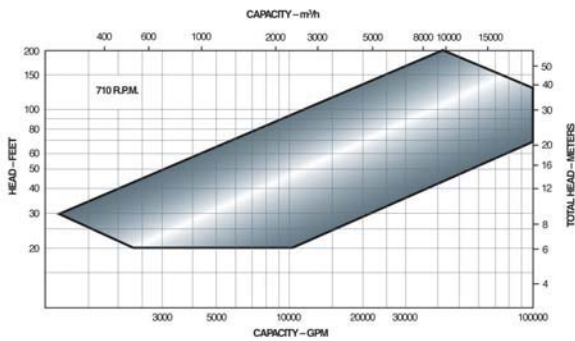
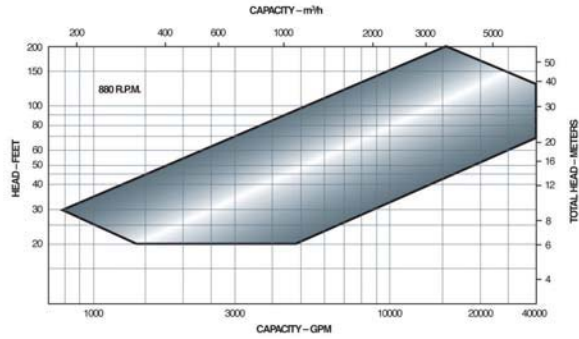
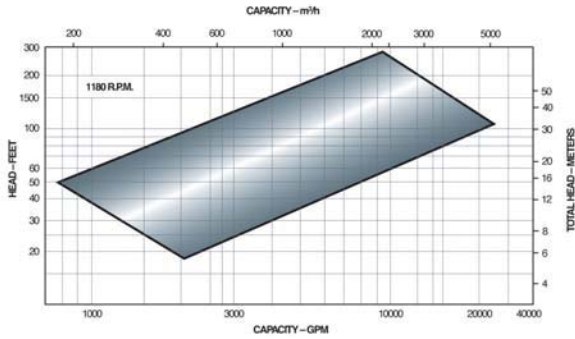
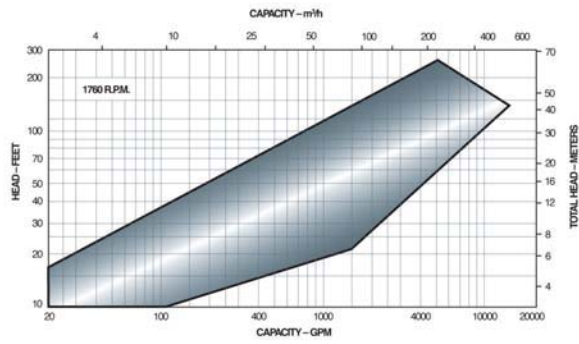
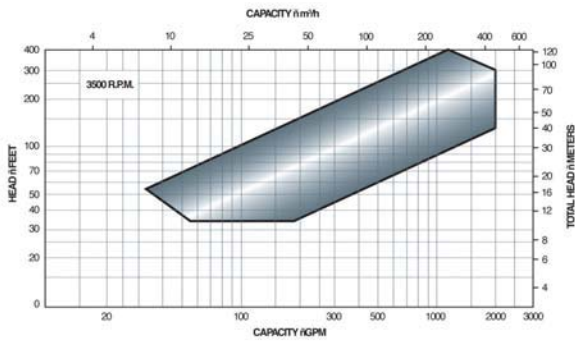

* Head is per stage.

High Capacity Pumps

Model WC-GP

DESIGN FEATURES FOR OPTIMUM EFFICIENCY, RELIABILITY AND COST SAVINGS

- Hydraulic selection at best efficiency point using advanced 3-D tools with parametric design. Each pump is designed for optimum hydraulic and mechanical conditions for the required application. The suction bell provides flared inlet controls to accelerate the fluid to the desired inlet velocity. Outer wall on the bowls provides structural integrity and the flanges with precise rabbet fits are located at each end for positive alignment. The contour of the diffuser/bowl provides accurate fit to the impeller for optimum operating efficiency.
- Cantilever rotor design with no tail bearings. Extra long length bearing or double bearing for added stability in the upper bearing above the first stage impeller. No auxiliary lubrication system needed. The process fluid ensures proper lubrication at all times for increased life expectancy. Elimination of the tail bearing provides lower NPSHR values and improved fluid inlet conditions for hydraulic performance.
- Computational fluid dynamic analysis is available to determine the sump flow conditions at the pump inlet for superior performance.
- Using a thermal casting solidification simulation program, Goulds Pumps is able to design optimum castings to meet specific customer conditions, providing better design standards in the market.
- Shaft sleeves optional. Provides renewable bushings. Prevents wear of shaft itself. Materials can be provided to resist abrasion which are not available in shafting in some cases. Recommended on large shafts due to the shaft replacement cost and lead times.
- Pull-out design is optional. This option provides an effective way to maintain the equipment and replace wear components without the need to remove the complete pump and disconnect the flanges from the main pipe. The removable component is only the rotor for optimum reliability and to reduce costs during maintenance.

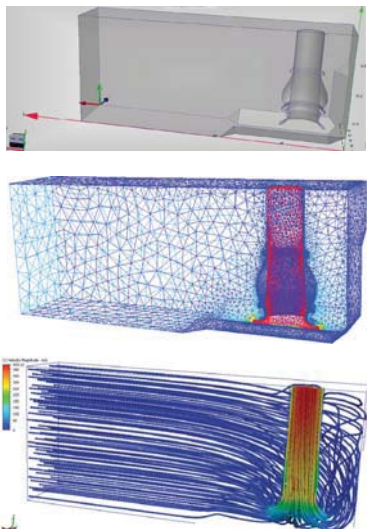

High Capacity Pumps

Model WC-GP

DESIGN FEATURES FOR OPTIMUM EFFICIENCY, RELIABILITY AND COST SAVINGS

- Innovative O-Head design using finite element analysis provides maximum equipment reliability throughout its operating hydraulic range without high vibrations from structural resonance frequency. In addition, lateral and torsional rotor analysis addresses unstable rotor dynamics.
- Thrust pot design is optional. It is designed to carry the pump down thrust generated by the rotor weight and the hydraulic action of the pump during operation. Thrust pots are ideally on units equipped with IEC motors where their thrust capacity is basically zero beyond the motor weight. Thrust pots are designed for easy dismantling without the need to remove the unit driver. Additional advantages include capacity of the thrust pot to withstand a large range of thrust forces, meeting international standards for bearing temperature and extended life, in addition to being air cooled for most of the applications.
- The hydraulic balance achieved on the rotor does not have balance holes in the impeller like other brands on the market. Reducing the down thrust of the pump will reduce the cost of the driver by reducing the size of the thrust bearing in the motor, which makes the Goulds Pumps design more competitive.
- Below-grade discharge elbow is optional, and the structural analysis design considers the overturning forces with respect to the anchor bolt location and pump centerline. This results in robust components to prevent equipment deformation. Discharge heads are designed to withhold certain discharge hydraulic and mechanical forces. It is always recommended to minimize these external forces by supporting the system independently. Do not use the rotating equipment as a piping anchor.



High Capacity & Higher Head Pumps

Model WC-GP

Vertical circulating water pumps or wet pit column pumps are classified as VS1 pumps for power generation condenser cooling, recirculation and desalination sea water intake, and as VS3 pumps for flood protection, storm water disposal, waste treatment plants, industrial services, and sump drainage.

High capacity pumps having a CCW (counter clockwise) rotation when viewing the equipment from the top meet Hydraulic Industry Standards and are in full compliance.

These high capacity pumps can be designed in multistage with a HEAVY DUTY configuration for a wide range of heads and extended service life, and are ideal when the installation requires minimum floor space.

Pumps ship completely assembled to the job site as long as they fit within freight dimension limitations. Pumps are shipped in sub-assemblies when the complete assembly exceeds the capacity of the transportation.

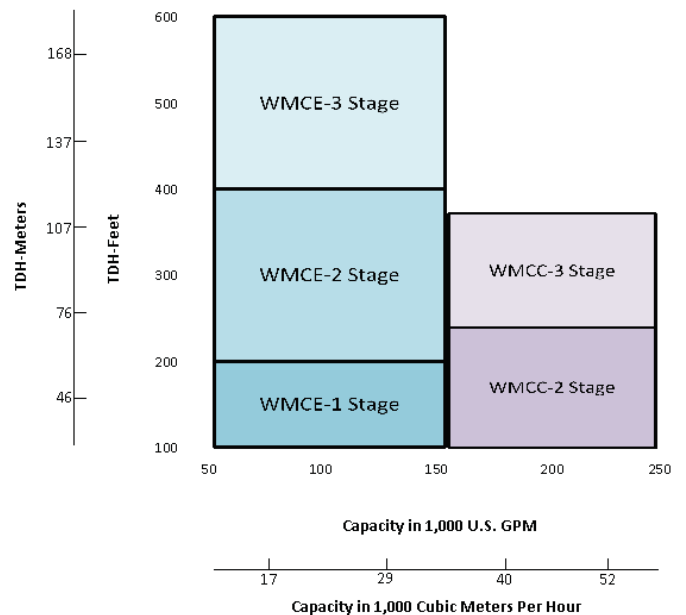
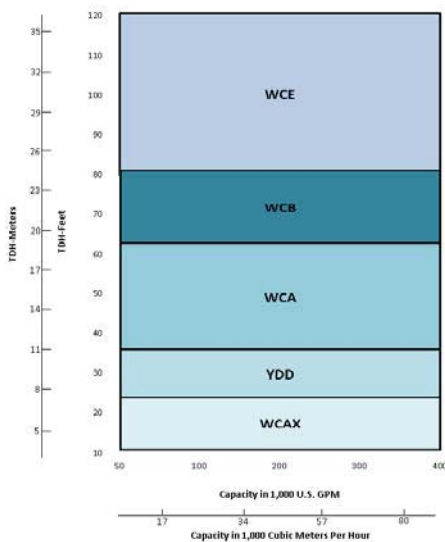

PRO services

Reliability has no quitting time.

Building on over 160 years of Goulds Pumps experience, **PRO Services** provides an array of services focused on reducing equipment total cost of ownership (TCO) and increasing plant output, including predictive monitoring, maintenance contracts, field service, engineered upgrades, inventory management, and overhauls for pumps and other rotating equipment.

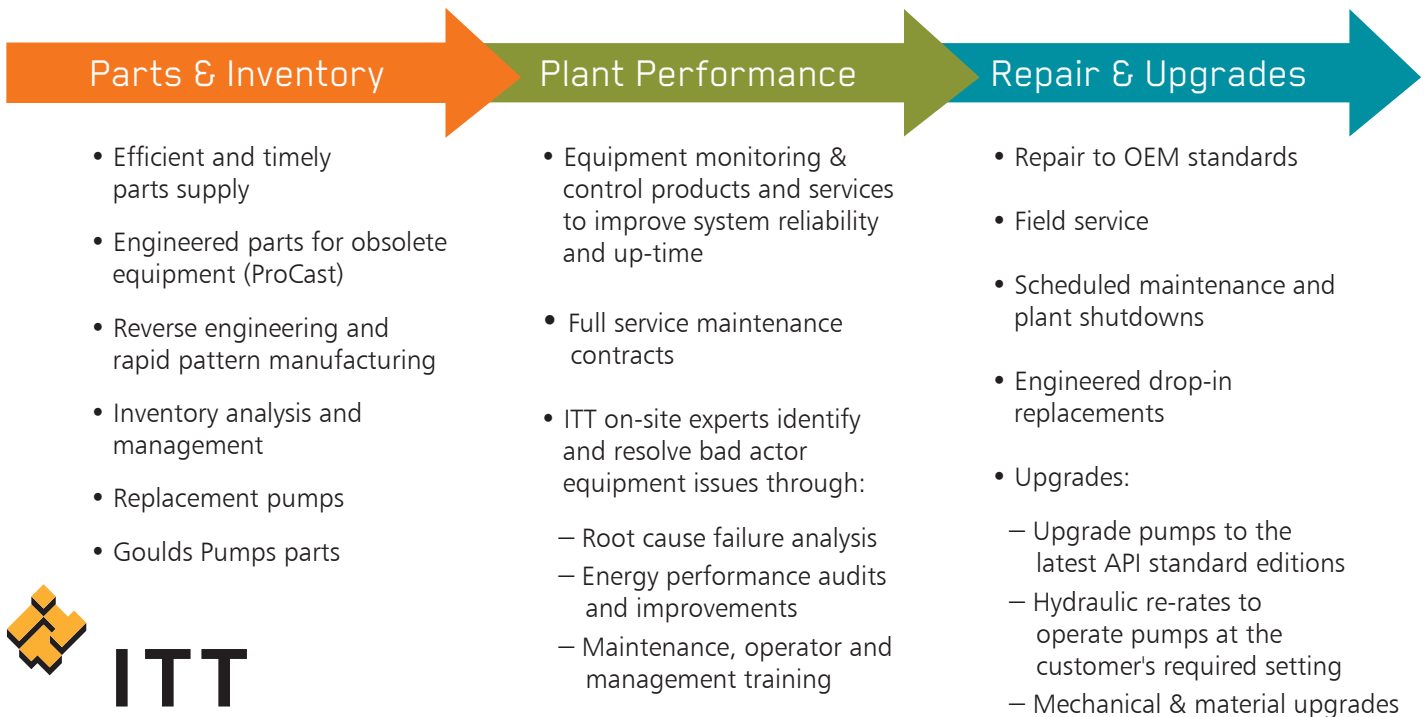
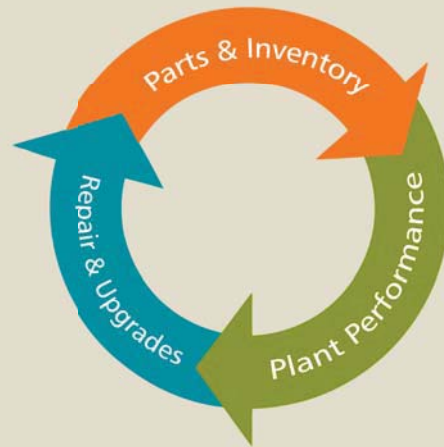

ENGINEERED FOR LIFE